



Contact us!

✉ zwj588@yahong-ortho.com

☎ +86-571-85787072 🌐 www.yahongortho.com

📍 No.788, Yongjun Road, Dipu street, Anji 313300
Zhejiang, China



ORTHODONTIC
CATALOG 



Company Profile

Zhejiang Yahong Medical Apparatus Co., Ltd was founded in 2006. It is a manufacturer that specializes in the development, production and sales of orthodontic products and endodontic products. Owing a modern production and R&D base of more than 15,000 square meters, Yahong has successfully used the technology of MIM and Automatic production line in the production of products. Automated manufacturing is increasing the quality and consistency of the products, which makes us in the leading position in these industries all the time.

YAHONG over the years has always adhered to the business purposes of "quality of products in order to survive, credibility and development". Committed to providing you with high-quality products and quality services, Yahong has a professional and dedicated design management team, from product design, mold making, molding to the product inspection and packing, for each aspect and processes are rigorously tested and controlled. Our products has been certified to ISO-13485, EU CE quality system and U.S. FDA.

YAHONG have always implemented the concept of customer value and creation for customers tailored products to meet the needs of different customers, and our products has been exported to more than 70 countries. Warmly welcome you to visit our factory, we will be your best partner and supplier.

CE FDA ISO13485 FSC

Certificates



Google maps

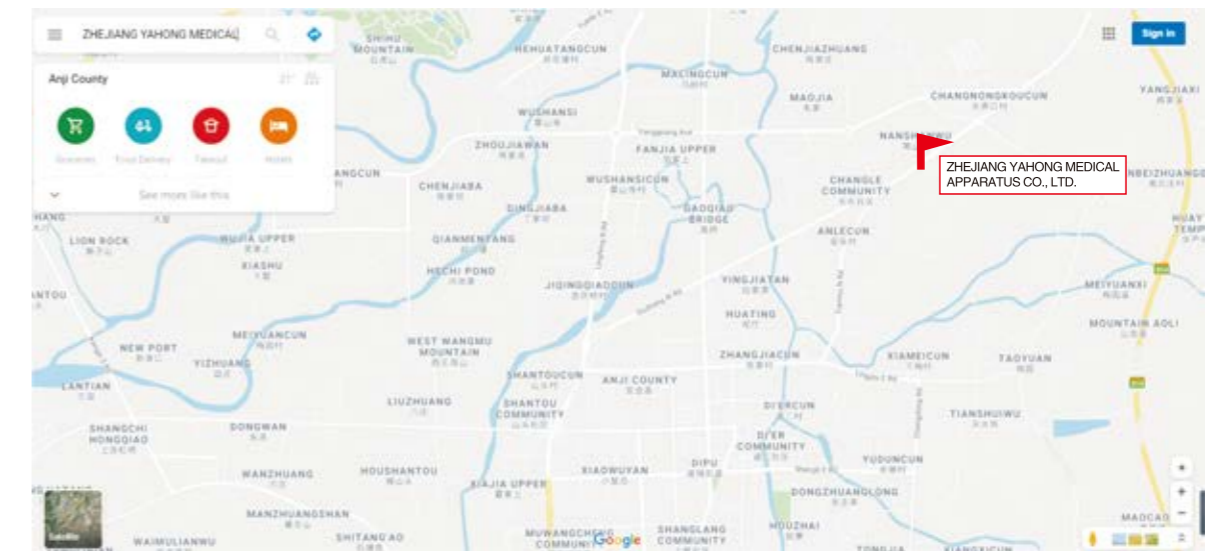

Catalogue



- 1 Brackets 05-69
- 2 Buccal Tubes 70-86
- 3 Bands 87-114
- 4 Archwires 115-124
- 5 Elastic-Rings 125-135
- 6 Inside Oral Cavity 136-144
- 7 Outside Oral Cavity 145-149
- 8 Orthodontic Pliers 150-153
- 9 Orthodontic Tools 154-154



17	16	15	14	13	12	11	21	22	23	24	25	26	27
7	6	5	4	3	2	1	1	2	3	4	5	6	7
7	6	5	4	3	2	1	1	2	3	4	5	6	7
47	46	45	44	43	42	41	31	32	33	34	35	36	37

UR7	UR6	UR5	UR4	UR3	UR2	UR1	UL1	UL2	UL3	UL4	UL5	UL6	UL7
7	6	5	4	3	2	1	1	2	3	4	5	6	7
7	6	5	4	3	2	1	1	2	3	4	5	6	7
LR7	LR6	LR5	LR4	LR3	LR2	LR1	LL1	LL2	LL3	LL4	LL5	LL6	LL7

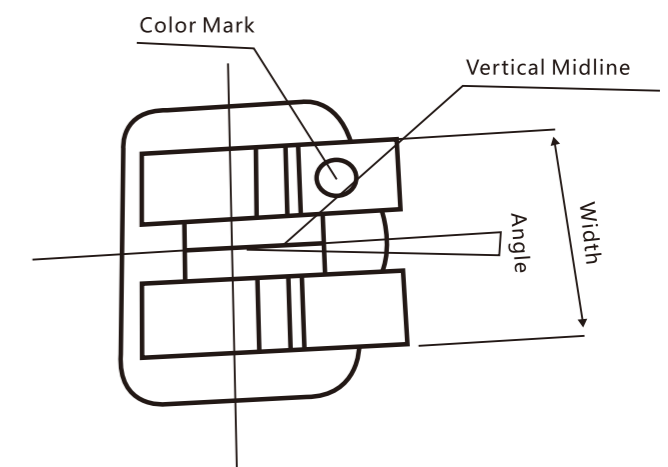
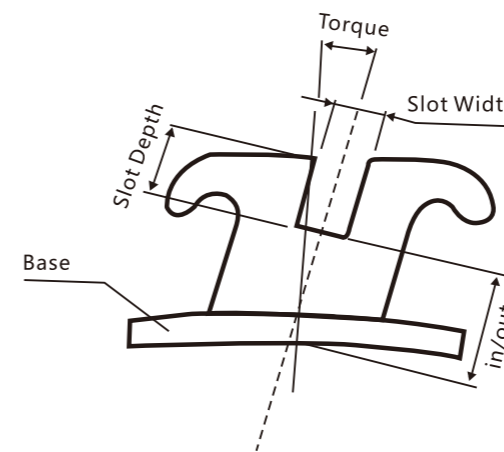

Orthodontic Brackets



■ MIM Series Brackets	05–38
■ CNC Series Brackets	39–46
■ Ceramic Series Brackets	47–56
■ Sapphire Series Brackets	57–61
■ Other Series Brackets	62–69

MIM Series Brackets

Self-Ligating Brackets

1. Self-Ligating Brackets 9G Pro
Roth/MBT/Standard/High/Low Torque
2. Self-Ligating Brackets 9G
Roth/MBT
3. Self-Ligating Brackets 9G Plus
Roth/MBT
4. Self-Ligating Brackets FlexiPull
Roth/MBT
5. Self-Ligating Brackets 7G Max
Standard/High/Low Torque
6. Self-Ligating Brackets 7G
Standard/High/Low Torque
7. Self-Ligating Brackets 5G Plus
Roth/MBT
8. Self-Ligating Brackets 5G
Roth/MBT
9. Self-Ligating Brackets 3G
Roth/MBT
10. Active Self-Ligating Brackets MA1
Roth/MBT
11. Active Self-Ligating Bracket MA2
Roth/MBT

Mini Brackets

1. Roth Brackets
2. MBT Brackets
3. Edgewise Brackets

Standard Brackets

1. Roth Brackets
2. MBT Brackets
3. Edgewise Brackets

Monoblock Mini Brackets

1. Roth Brackets 1G
2. Roth Brackets 3G
3. Roth Brackets 4G
4. MBT Brackets 1G
5. MBT Brackets 3G
6. Edgewise Brackets

CNC Series Brackets

Mini Brackets

1. Roth Brackets
2. MBT Brackets
3. Edgewise Brackets
4. V-slot Roth Brackets
5. V-slot MBT Brackets
6. Ricketts Brackets

Standard Brackets

1. Roth Brackets
2. MBT Brackets
3. Edgewise Brackets
4. V-slot Roth Brackets
5. V-slot MBT Brackets
6. Ricketts Brackets
7. Gemini Roth Brackets
8. Gemini MBT Brackets

Ceramic Series Brackets

Ceramic Self Ligating Brackets

1. Roth Brackets G Series
2. MBT Brackets G Series
3. Roth Brackets 7G
4. MBT Brackets 7G
5. Roth Brackets 2G
6. MBT Brackets 2G

Ceramic Brackets

1. Roth Brackets Three Groove
2. MBT Brackets Three Groove
3. Edgewise Brackets Three Groove
4. Roth Brackets Gridding
5. MBT Brackets Gridding
6. Edgewise Brackets Gridding
7. Ceramic Roth Bracket 2G
8. Ceramic MBT Bracket 2G
9. Ceramic Roth Bracket 3G
10. Ceramic MBT Bracket 3G

Sapphire Series Brackets

Sapphire Brackets

1. Roth Brackets
2. MBT Brackets
3. Edgewise Brackets
4. Roth Brackets with Indicator
5. MBT Brackets with Indicator

Other Series Brackets

1. VS Synchronous Brackets
2. Lingual Brackets
3. Alexander Brackets
4. Light Force Brackets (six-wing Brackets)
5. Molar Brackets
6. Begg Brackets
7. Fashion Brackets
8. Gold Plated Brackets

MIM Series Brackets >> Self-Ligating Brackets 9G Pro



The patented T-shaped design ensures stable traction, precise 3D control, and higher efficiency in complex orthodontic cases



The design of a small circular dot at the center facilitates the use of probes by doctors in clinical practice, ensuring accurate and error free bonding and positioning of self-locking brackets

Corrective force applied closer to the center of resistance enables more precise root control



Innovative low-friction self-ligating design enables lightweight, secure ligation and improved control of tooth rotation



Circular design appearance to avoid food residue and ensure oral hygiene



Self-Ligating Roth Brackets 9G Pro



MAXILLARY ▲	Torque	Angle	In/out	Width	0.022 3WK		0.022 345WK		
					R	L	R	L	
Central	1 1	12°	5°	0.9	3.3	SRHD-1011	SRHD-1021	SRHD-1011	SRHD-1021
Lateral	2 2	8°	9°	1.1	3.1	SRHD-1012	SRHD-1022	SRHD-1012	SRHD-1022
Cuspid	3 3	-2°	11°	0.8	3.3	SRHD-1113	SRHD-1123	SRHD-1113	SRHD-1123
Bicuspid	4 4	-7°	0°	0.8	3.1	SRHD-1014	SRHD-1024	SRHD-1114	SRHD-1124
Bicuspid	5 5	-7°	0°	0.8	3.1	SRHD-1015	SRHD-1025	SRHD-1115	SRHD-1125

MANDIBULAR ▼	Torque	Angle	In/out	Width	0.022 3WK		0.022 345WK		
					R	L	R	L	
Lower Anterior	1 1	-1°	0°	1.1	3.1	SRHD-1041	SRHD-1031	SRHD-1041	SRHD-1031
Lower Anterior	2 2	-1°	0°	1.1	3.1	SRHD-1042	SRHD-1032	SRHD-1042	SRHD-1032
Cuspid	3 3	-11°	5°	0.8	3.1	SRHD-1143	SRHD-1133	SRHD-1143	SRHD-1133
1st Bicuspid	4 4	-17°	0°	0.8	3.1	SRHD-1044	SRHD-1034	SRHD-1144	SRHD-1134
2nd Bicuspid	5 5	-22°	0°	0.8	3.1	SRHD-1045	SRHD-1035	SRHD-1145	SRHD-1135

Full Kits ▲▼

20pcs/kit

Kits	package	3with hook	345with hook
.022	with laser mark	SRHD-02	SRHD-03

Self-Ligating MBT Brackets 9G Pro



MAXILLARY ▲	Torque	Angle	In/out	Width	0.022 3WK		0.022 345WK		
					R	L	R	L	
Central	1 1	17°	4°	0.9	3.3	SMHD-1011	SMHD-1021	SMHD-1011	SMHD-1021
Lateral	2 2	10°	8°	1.1	3.1	SMHD-1012	SMHD-1022	SMHD-1012	SMHD-1022
Cuspid	3 3	0°	8°	0.8	3.3	SMHD-1113	SMHD-1123	SMHD-1113	SMHD-1123
Bicuspid	4 4	-7°	0°	0.8	3.1	SMHD-1014	SMHD-1024	SMHD-1114	SMHD-1124
Bicuspid	5 5	-7°	0°	0.8	3.1	SMHD-1015	SMHD-1025	SMHD-1115	SMHD-1125

MANDIBULAR ▼	Torque	Angle	In/out	Width	0.022 3WK		0.022 345WK		
					R	L	R	L	
Lower Anterior	1 1	-6°	0°	1.1	3.1	SMHD-1041	SMHD-1031	SMHD-1041	SMHD-1031
Lower Anterior	2 2	-6°	0°	1.1	3.1	SMHD-1042	SMHD-1032	SMHD-1042	SMHD-1032
Cuspid	3 3	0°	3°	0.8	3.3	SMHD-1143	SMHD-1133	SMHD-1143	SMHD-1133
1st Bicuspid	4 4	-12°	2°	0.8	3.1	SMHD-1044	SMHD-1034	SMHD-1144	SMHD-1134
2nd Bicuspid	5 5	-17°	2°	0.8	3.1	SMHD-1045	SMHD-1035	SMHD-1145	SMHD-1135

Full Kits ▲▼

20pcs/kit

Kits	package	3with hook	345with hook
.022	with laser mark	SMHD-02	SMHD-03



Self-Ligating Standard Torque Brackets 9G Pro

MAXILLARY ▲	Torque	Angle	In/out	Width	0.022 3WK		0.022 345WK		
					R	L	R	L	
Central	1 1	15°	5°	0.9	3.3	SSHD-1011	SSHD-1021	SSHD-1011	SSHD-1021
Lateral	2 2	6°	9°	1.1	3.1	SSHD-1012	SSHD-1022	SSHD-1012	SSHD-1022
Cuspid	3 3	7°	5°	0.8	3.3	SSHD-1113	SSHD-1123	SSHD-1113	SSHD-1123
Bicuspid	4 4	-11°	2°	0.8	3.1	SSHD-1014	SSHD-1024	SSHD-1114	SSHD-1124
Bicuspid	5 5	-11°	2°	0.8	3.1	SSHD-1015	SSHD-1025	SSHD-1115	SSHD-1125

MANDIBULAR ▼	Torque	Angle	In/out	Width	0.022 3WK		0.022 345WK		
					R	L	R	L	
Lower Anterior	1 1	-3°	2°	1.1	3.1	SSHD-1041	SSHD-1031	SSHD-1041	SSHD-1031
Lower Anterior	2 2	-3°	4°	1.1	3.1	SSHD-1042	SSHD-1032	SSHD-1042	SSHD-1032
Cuspid	3 3	7°	5°	0.8	3.3	SSHD-1143	SSHD-1133	SSHD-1143	SSHD-1133
1st Bicuspid	4 4	-12°	4°	0.8	3.1	SSHD-1044	SSHD-1034	SSHD-1144	SSHD-1134
2nd Bicuspid	5 5	-17°	4°	0.8	3.1	SSHD-1045	SSHD-1035	SSHD-1145	SSHD-1135

Full Kits ▲▼

20pcs/kit

Kits	package	3with hook	345with hook
.022	with laser mark	SSHD-02	SSHD-03



Self-Ligating High Torque Brackets 9G Pro

MAXILLARY ▲	Torque	Angle	In/out	Width	0.022 3WK		0.022 345WK		
					R	L	R	L	
Central	1 1	22°	5°	0.9	3.3	SHHD-1011	SHHD-1021	SHHD-1011	SHHD-1021
Lateral	2 2	13°	9°	1.1	3.1	SHHD-1012	SHHD-1022	SHHD-1012	SHHD-1022
Cuspid	3 3	11°	5°	0.8	3.3	SHHD-1113	SHHD-1123	SHHD-1113	SHHD-1123
Bicuspid	4 4	-11°	2°	0.8	3.1	SHHD-1014	SHHD-1024	SHHD-1114	SHHD-1124
Bicuspid	5 5	-11°	2°	0.8	3.1	SHHD-1015	SHHD-1025	SHHD-1115	SHHD-1125

MANDIBULAR ▼	Torque	Angle	In/out	Width	0.022 3WK		0.022 345WK		
					R	L	R	L	
Lower Anterior	1 1	-3°	2°	1.1	3.1	SHHD-1041	SHHD-1031	SHHD-1041	SHHD-1031
Lower Anterior	2 2	-3°	4°	1.1	3.1	SHHD-1042	SHHD-1032	SHHD-1042	SHHD-1032
Cuspid	3 3	7°	5°	0.8	3.3	SHHD-1143	SHHD-1133	SHHD-1143	SHHD-1133
1st Bicuspid	4 4	-12°	4°	0.8	3.1	SHHD-1044	SHHD-1034	SHHD-1144	SHHD-1134
2nd Bicuspid	5 5	-17°	4°	0.8	3.1	SHHD-1045	SHHD-1035	SHHD-1145	SHHD-1135

Full Kits ▲▼

20pcs/kit

Kits	package	3with hook	345with hook
.022	with laser mark	SHHD-02	SHHD-03



Self-Ligating Low Torque Brackets 9G Pro

MAXILLARY ▲	Torque	Angle	In/out	Width	0.022 3WK		0.022 345WK		
					R	L	R	L	
Central	1 1	2°	5°	0.9	3.3	SLHD-1011	SLHD-1021	SLHD-1011	SLHD-1021
Lateral	2 2	-5°	9°	1.1	3.1	SLHD-1012	SLHD-1022	SLHD-1012	SLHD-1022
Cuspid	3 3	-9°	5°	0.8	3.3	SLHD-1113	SLHD-1123	SLHD-1113	SLHD-1123
Bicuspid	4 4	-11°	2°	0.8	3.1	SLHD-1014	SLHD-1024	SLHD-1114	SLHD-1124
Bicuspid	5 5	-11°	2°	0.8	3.1	SLHD-1015	SLHD-1025	SLHD-1115	SLHD-1125

MANDIBULAR ▼	Torque	Angle	In/out	Width	0.022 3WK		0.022 345WK		
					R	L	R	L	
Lower Anterior	1 1	-11°	2°	1.1	3.1	SLHD-1041	SLHD-1031	SLHD-1041	SLHD-1031
Lower Anterior	2 2	-11°	4°	1.1	3.1	SLHD-1042	SLHD-1032	SLHD-1042	SLHD-1032
Cuspid	3 3	0°	5°	0.8	3.3	SLHD-1143	SLHD-1133	SLHD-1143	SLHD-1133
1st Bicuspid	4 4	-12°	4°	0.8	3.1	SLHD-1044	SLHD-1034	SLHD-1144	SLHD-1134
2nd Bicuspid	5 5	-17°	4°	0.8	3.1	SLHD-1045	SLHD-1035	SLHD-1145	SLHD-1135

Full Kits ▲▼

20pcs/kit

Kits	package	3with hook	345with hook
.022	with laser mark	SLHD-02	SLHD-03

MIM Series Brackets >> Self-Ligating Brackets 9G



The firm self-locking clip lock piece is smooth and stable, and can be opened and closed freely



Central positioning line design can assist brackets bonding positioning



ENLARGED LIGATION SPACE
Brand new tie-wing design more ligation space compared to other brackets

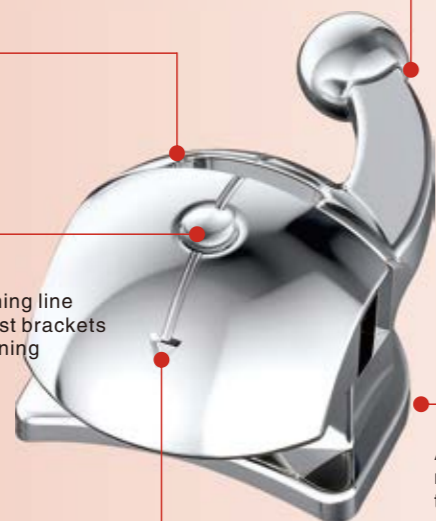

The towing hook is integrally formed, round and solid. The bottom of the towing hook is reinforced. It is strong and reliable and does not fall off. The ball head is easy for doctors to hang and tow

Adopting the latest 80 gauge mesh base technology makes the brackets more adhesive



Self-Ligating Roth Brackets 9G



MAXILLARY ▲	Torque	Angle	In/out	Width	0.022 with hook		0.022 no hook		
					R	L	R	L	
Central	1 1	12°	5°	2.3	3	SZQ2-1011	SZQ2-1021	SZQ2-1011	SZQ2-1021
Lateral	2 2	8°	9°	2.2	2.8	SZQ2-1012	SZQ2-1022	SZQ2-1012	SZQ2-1022
Cuspid	3 3	-2°	11°	2.3	2.8	SZQ2-1113	SZQ2-1123	SZQ2-1013	SZQ2-1023
Bicuspid	4 4	-7°	0°	2.4	2.8	SZQ2-1114	SZQ2-1124	SZQ2-1014	SZQ2-1024
Bicuspid	5 5	-7°	0°	2.4	2.8	SZQ2-1115	SZQ2-1125	SZQ2-1015	SZQ2-1025

MANDIBULAR ▼	Torque	Angle	In/out	Width	0.022 with hook		0.022 no hook		
					R	L	R	L	
Lower Anterior	1 1	-1°	0°	2.1	2.6	SZQ2-1041	SZQ2-1031	SZQ2-1041	SZQ2-1031
Lower Anterior	2 2	-1°	0°	2.1	2.6	SZQ2-1042	SZQ2-1032	SZQ2-1042	SZQ2-1032
Cuspid	3 3	-11°	5°	2.2	2.8	SZQ2-1143	SZQ2-1133	SZQ2-1043	SZQ2-1033
1st Bicuspid	4 4	-17°	0°	2.5	2.8	SZQ2-1144	SZQ2-1134	SZQ2-1044	SZQ2-1034
2nd Bicuspid	5 5	-22°	0°	2.5	2.8	SZQ2-1145	SZQ2-1135	SZQ2-1045	SZQ2-1035

Full Kits ▲▼

20pcs/kit

Kits	package	no hook	3with hook	345with hook
.022	with laser mark	SZQ2-01	SZQ2-02	SZQ2-03

Self-Ligating MBT Brackets 9G



MAXILLARY ▲	Torque	Angle	In/out	Width	0.022 with hook		0.022 no hook		
					R	L	R	L	
Central	1 1	17°	4°	2.3	3	SMQ2-1011	SMQ2-1021	SMQ2-1011	SMQ2-1021
Lateral	2 2	10°	8°	2.2	2.8	SMQ2-1012	SMQ2-1022	SMQ2-1012	SMQ2-1022
Cuspid	3 3	0°	8°	2.3	2.8	SMQ2-1113	SMQ2-1123	SMQ2-1013	SMQ2-1023
Bicuspid	4 4	-7°	0°	2.4	2.8	SMQ2-1114	SMQ2-1124	SMQ2-1014	SMQ2-1024
Bicuspid	5 5	-7°	0°	2.4	2.8	SMQ2-1115	SMQ2-1125	SMQ2-1015	SMQ2-1025

MANDIBULAR ▼	Torque	Angle	In/out	Width	0.022 with hook		0.022 no hook		
					R	L	R	L	
Lower Anterior	1 1	-6°	0°	2.1	2.6	SMQ2-1041	SMQ2-1031	SMQ2-1041	SMQ2-1031
Lower Anterior	2 2	-6°	0°	2.1	2.6	SMQ2-1042	SMQ2-1032	SMQ2-1042	SMQ2-1032
Cuspid	3 3	0°	3°	2.2	2.8	SMQ2-1143	SMQ2-1133	SMQ2-1043	SMQ2-1033
1st Bicuspid	4 4	-12°	2°	2.5	2.8	SMQ2-1144	SMQ2-1134	SMQ2-1044	SMQ2-1034
2nd Bicuspid	5 5	-17°	2°	2.5	2.8	SMQ2-1145	SMQ2-1135	SMQ2-1045	SMQ2-1035

Full Kits ▲▼

20pcs/kit

Kits	package	no hook	3with hook	345with hook
.022	with laser mark	SMQ2-01	SMQ2-02	SMQ2-03

MIM Series Brackets >> Self-Ligating Brackets 9G Plus

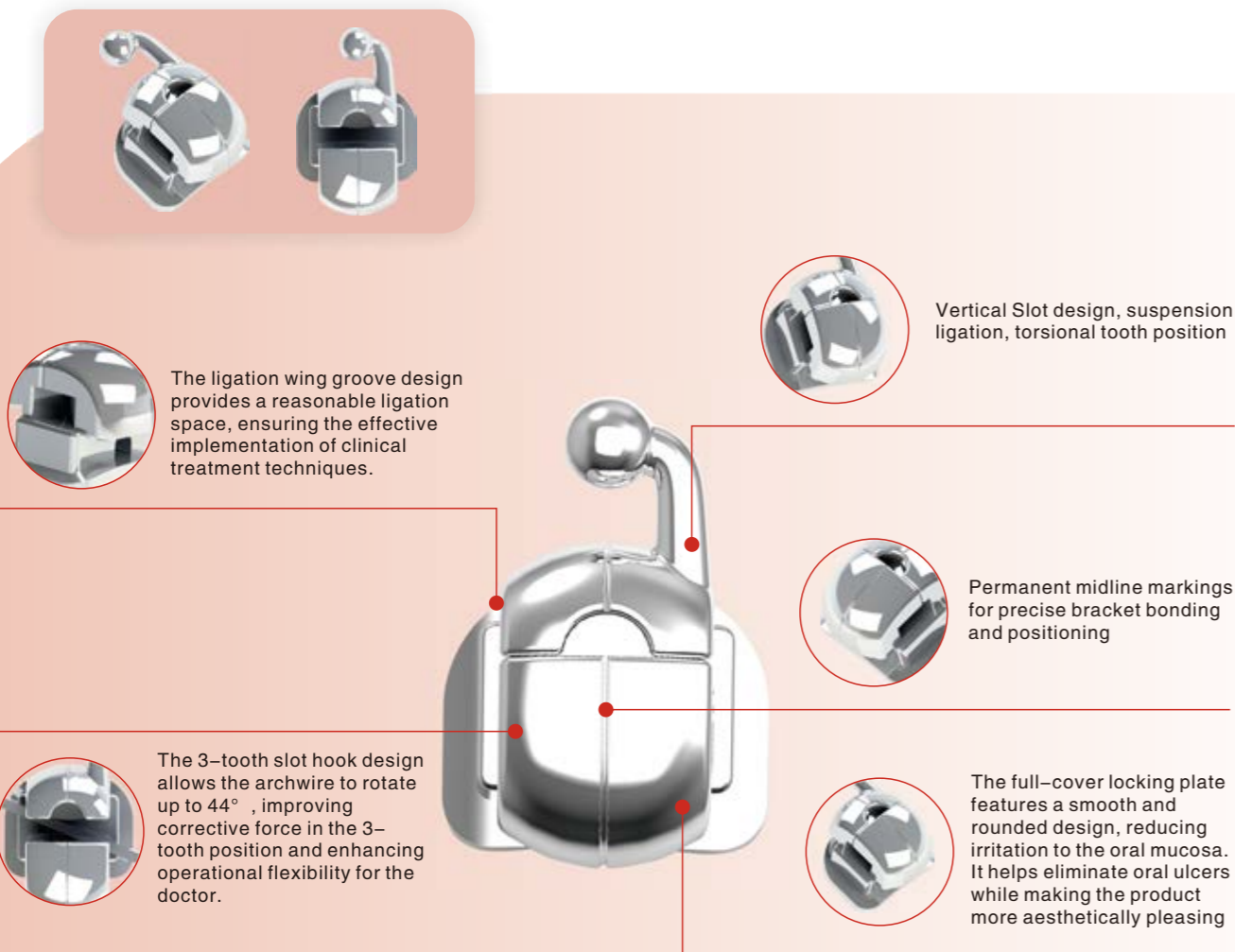

Self-Ligating Roth Brackets 9G Plus

MAXILLARY ▲	Torque	Angle	In/out	Width	0.022 3WK		0.022 345WK		
					R	L	R	L	
Central	1 1	12°	5°	2.3	3	SZQP-1011	SZQP-1021	SZQP-1011	SZQP-1021
Lateral	2 2	8°	9°	2.2	2.8	SZQP-1012	SZQP-1022	SZQP-1012	SZQP-1022
Cuspid	3 3	0°	0°	2.8	3	SZQP-1113	SZQP-1123	SZQP-1113	SZQP-1123
Bicuspid	4 4	-7°	0°	2.4	2.8	SZQP-1014	SZQP-1024	SZQP-1114	SZQP-1124
Bicuspid	5 5	-7°	0°	2.4	2.8	SZQP-1015	SZQP-1025	SZQP-1115	SZQP-1125

MANDIBULAR ▼	Torque	Angle	In/out	Width	0.022 3WK		0.022 345WK		
					R	L	R	L	
Lower Anterior	1 1	-1°	0°	2.1	2.6	SZQP-1041	SZQP-1031	SZQP-1041	SZQP-1031
Lower Anterior	2 2	-1°	0°	2.1	2.6	SZQP-1042	SZQP-1032	SZQP-1042	SZQP-1032
Cuspid	3 3	0°	0°	2.8	3	SZQP-1143	SZQP-1133	SZQP-1143	SZQP-1133
1st Bicuspid	4 4	-17°	0°	2.5	2.8	SZQP-1044	SZQP-1034	SZQP-1144	SZQP-1134
2nd Bicuspid	5 5	-22°	0°	2.5	2.8	SZQP-1045	SZQP-1035	SZQP-1145	SZQP-1135

Full Kits ▲▼

20pcs/kit

Kits	package	3with hook	345with hook
.022	with laser mark	SZQP-02	SZQP-03

Self-Ligating MBT Brackets 9G Plus

MAXILLARY ▲	Torque	Angle	In/out	Width	0.022 3WK		0.022 345WK		
					R	L	R	L	
Central	1 1	17°	4°	2.3	3	SMQP-1011	SMQP-1021	SMQP-1011	SMQP-1021
Lateral	2 2	10°	8°	2.2	2.8	SMQP-1012	SMQP-1022	SMQP-1012	SMQP-1022
Cuspid	3 3	0°	0°	2.8	3	SMQP-1113	SMQP-1123	SMQP-1113	SMQP-1123
Bicuspid	4 4	-7°	0°	2.4	2.8	SMQP-1014	SMQP-1024	SMQP-1114	SMQP-1124
Bicuspid	5 5	-7°	0°	2.4	2.8	SMQP-1015	SMQP-1025	SMQP-1115	SMQP-1125

MANDIBULAR ▼	Torque	Angle	In/out	Width	0.022 3WK		0.022 345WK		
					R	L	R	L	
Lower Anterior	1 1	-6°	0°	2.1	2.6	SMQP-1041	SMQP-1031	SMQP-1041	SMQP-1031
Lower Anterior	2 2	-6°	0°	2.1	2.6	SMQP-1042	SMQP-1032	SMQP-1042	SMQP-1032
Cuspid	3 3	0°	0°	2.8	3	SMQP-1143	SMQP-1133	SMQP-1143	SMQP-1133
1st Bicuspid	4 4	-12°	2°	2.5	2.8	SMQP-1044	SMQP-1034	SMQP-1144	SMQP-1134
2nd Bicuspid	5 5	-17°	2°	2.5	2.8	SMQP-1045	SMQP-1035	SMQP-1145	SMQP-1135

Full Kits ▲▼

20pcs/kit

Kits	package	3with hook	345with hook
.022	with laser mark	SMQP-02	SMQP-03

MIM Series Brackets >> Self-Ligating Brackets FlexiPull

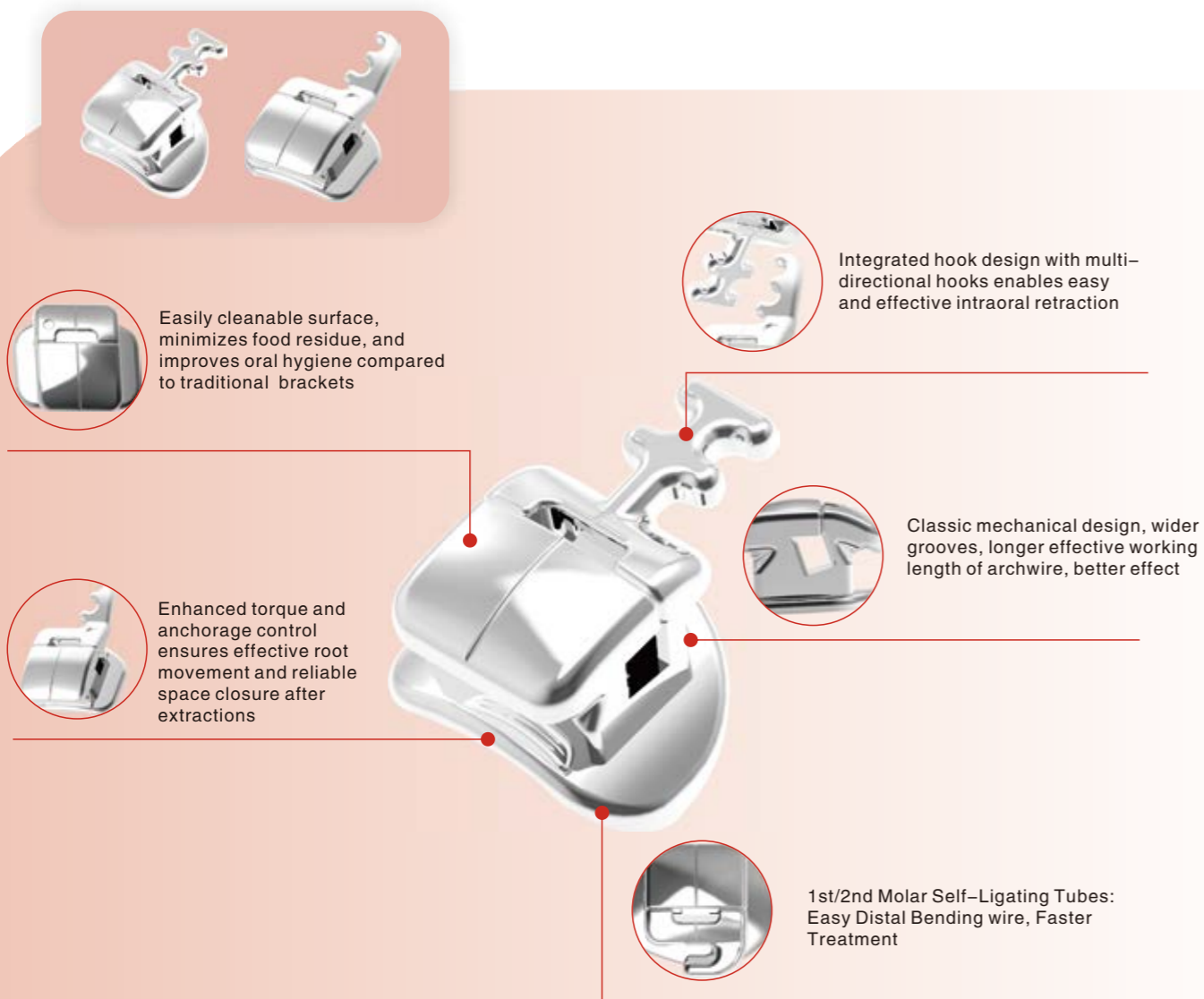

Self-Ligating Roth Brackets FlexiPull

MAXILLARY ▲	Torque	Angle	In/out	Width	0.022 with hook		
					R	L	
Central	1 1	12°	5°	2.6	3	SZHY-1011	SZHY-1021
Lateral	2 2	8°	9°	2.6	2.8	SZHY-1012	SZHY-1022
Cuspid	3 3	-2°	11°	3	3	SZHY-1113	SZHY-1123
Bicuspid	4 4	-7°	0°	2.8	3	SZHY-1014	SZHY-1024
Bicuspid	5 5	-7°	0°	2.8	3	SZHY-1115	SZHY-1125
Molar	6 6	-14°	10°	2.8	4	SZHY-1116	SZHY-1126
Molar	7 7	-14°	10°	2.8	3.2	SZHY-1117	SZHY-1127

MANDIBULAR ▼	Torque	Angle	In/out	Width	0.022 with hook		
					R	L	
Lower Anterior	1 1	-1°	0°	2.6	2.8	SZHY-1041	SZHY-1031
Lower Anterior	2 2	-1°	0°	2.6	2.8	SZHY-1042	SZHY-1032
Cuspid	3 3	-11°	5°	3	3	SZHY-1143	SZHY-1133
1st Bicuspid	4 4	-17°	0°	2.8	3	SZHY-1044	SZHY-1034
2nd Bicuspid	5 5	-22°	0°	2.8	3	SZHY-1145	SZHY-1135
1st Molar	6 6	-25°	4°	2.8	4	SZHY-1146	SZHY-1136
2nd Molar	7 7	-25°	4°	2.8	3.2	SZHY-1147	SZHY-1137

Full Kits ▲▼			28PCS/SET
Kits	package	with hook	
.022	with laser mark	SZHY-01	

Self-Ligating MBT Brackets FlexiPull

MAXILLARY ▲	Torque	Angle	In/out	Width	0.022 with hook		
					R	L	
Central	1 1	17°	4°	2.6	3	SMHY-1011	SMHY-1021
Lateral	2 2	10°	8°	2.6	2.8	SMHY-1012	SMHY-1022
Cuspid	3 3	0°	8°	3	3	SMHY-1113	SMHY-1123
Bicuspid	4 4	-7°	0°	2.8	3	SMHY-1014	SMHY-1024
Bicuspid	5 5	-7°	0°	2.8	3	SMHY-1115	SMHY-1125
Molar	6 6	-14°	10°	2.8	4	SMHY-1116	SMHY-1126
Molar	7 7	-14°	10°	2.8	3.2	SMHY-1117	SMHY-1127

MANDIBULAR ▼	Torque	Angle	In/out	Width	0.022 with hook		
					R	L	
Lower Anterior	1 1	-6°	0°	2.6	2.8	SMHY-1041	SMHY-1031
Lower Anterior	2 2	-6°	0°	2.6	2.8	SMHY-1042	SMHY-1032
Cuspid	3 3	0°	3°	3	3	SMHY-1143	SMHY-1133
1st Bicuspid	4 4	-12°	2°	2.8	3	SMHY-1044	SMHY-1034
2nd Bicuspid	5 5	-17°	2°	2.8	3	SMHY-1145	SMHY-1135
1st Molar	6 6	-20°	0°	2.8	4	SMHY-1146	SMHY-1136
2nd Molar	7 7	-10°	0°	2.8	3.2	SMHY-1147	SMHY-1137

Full Kits ▲▼			28PCS/SET
Kits	package	with hook	
.022	with laser mark	SMHY-01	

MIM Series Brackets >> Self-Ligating Brackets 7G Max



7G Max



Enhanced torque control through slot design improves precision and reduces friction resistance



Easy-Clean Innovation for Better Oral Care



Central Dot Design: Precision Fixation for Easy Adhesive Placement



Horizontal Auxiliary Slot
The 0.42 x 0.42 mm slot allows for double archwire techniques and light-force control, enhancing treatment precision in complex cases



The design of the activity hook makes the traction more flexible

Self-Ligating Standard Torque Brackets 7G Max



MAXILLARY ▲	Torque	Angle	In/out	Width	0.022 with hook		0.022 no hook		
					R	L	R	L	
Central	1 1	15°	5°	0.9	3	SS7M-1011	SS7M-1021	SS7M-1011	SS7M-1021
Lateral	2 2	6°	9°	1.1	3	SS7M-1012	SS7M-1022	SS7M-1012	SS7M-1022
Cuspid	3 3	7°	5°	0.8	3	SS7M-1113	SS7M-1123	SS7M-1013	SS7M-1023
Bicuspid	4 4	-11°	2°	0.8	3	SS7M-1114	SS7M-1124	SS7M-1014	SS7M-1024
Bicuspid	5 5	-11°	2°	0.8	3	SS7M-1115	SS7M-1125	SS7M-1015	SS7M-1025

MANDIBULAR ▼	Torque	Angle	In/out	Width	0.022 with hook		0.022 no hook		
					R	L	R	L	
Lower Anterior	1 1	-3°	2°	1.1	3	SS7M-1041	SS7M-1031	SS7M-1041	SS7M-1031
Lower Anterior	2 2	-3°	4°	1.1	3	SS7M-1042	SS7M-1032	SS7M-1042	SS7M-1032
Cuspid	3 3	7°	5°	0.8	3	SS7M-1143	SS7M-1133	SS7M-1043	SS7M-1033
1st Bicuspid	4 4	-12°	4°	0.8	3	SS7M-1144	SS7M-1134	SS7M-1044	SS7M-1034
2nd Bicuspid	5 5	-17°	4°	0.8	3	SS7M-1145	SS7M-1135	SS7M-1045	SS7M-1035

Full Kits ▲▼

20pcs/kit

Kits	package	no hook	3with hook	345with hook
.022	Standard Torque	SS7M-01	SS7M-02	SS7M-03

Self-Ligating High Torque Brackets 7G Max



MAXILLARY ▲	Torque	Angle	In/out	Width	0.022 with hook		0.022 no hook		
					R	L	R	L	
Central	1 1	22°	5°	0.9	3	SH7M-1011	SH7M-1021	SH7M-1011	SH7M-1021
Lateral	2 2	13°	9°	1.1	3	SH7M-1012	SH7M-1022	SH7M-1012	SH7M-1022
Cuspid	3 3	11°	5°	0.8	3	SH7M-1113	SH7M-1123	SH7M-1013	SH7M-1023
Bicuspid	4 4	-11°	2°	0.8	3	SH7M-1114	SH7M-1124	SH7M-1014	SH7M-1024
Bicuspid	5 5	-11°	2°	0.8	3	SH7M-1115	SH7M-1125	SH7M-1015	SH7M-1025

MANDIBULAR ▼	Torque	Angle	In/out	Width	0.022 with hook		0.022 no hook		
					R	L	R	L	
Lower Anterior	1 1	-3°	2°	1.1	3	SH7M-1041	SH7M-1031	SH7M-1041	SH7M-1031
Lower Anterior	2 2	-3°	4°	1.1	3	SH7M-1042	SH7M-1032	SH7M-1042	SH7M-1032
Cuspid	3 3	7°	5°	0.8	3	SH7M-1143	SH7M-1133	SH7M-1043	SH7M-1033
1st Bicuspid	4 4	-12°	4°	0.8	3	SH7M-1144	SH7M-1134	SH7M-1044	SH7M-1034
2nd Bicuspid	5 5	-17°	4°	0.8	3	SH7M-1145	SH7M-1135	SH7M-1045	SH7M-1035

Full Kits ▲▼

20pcs/kit

Kits	package	no hook	3with hook	345with hook
.022	High Torque	SH7M-01	SH7M-02	SH7M-03

Self-Ligating Low Torque Brackets 7G Max



MAXILLARY ▲	Torque	Angle	In/out	Width	0.022 with hook		0.022 no hook		
					R	L	R	L	
Central	1 1	2°	5°	0.9	3	SL7M-1011	SL7M-1021	SL7M-1011	SL7M-1021
Lateral	2 2	-5°	9°	1.1	3	SL7M-1012	SL7M-1022	SL7M-1012	SL7M-1022
Cuspid	3 3	-9°	5°	0.8	3	SL7M-1113	SL7M-1123	SL7M-1013	SL7M-1023
Bicuspid	4 4	-11°	2°	0.8	3	SL7M-1114	SL7M-1124	SL7M-1014	SL7M-1024
Bicuspid	5 5	-11°	2°	0.8	3	SL7M-1115	SL7M-1125	SL7M-1015	SL7M-1025

MANDIBULAR ▼	Torque	Angle	In/out	Width	0.022 with hook		0.022 no hook		
					R	L	R	L	
Lower Anterior	1 1	-11°	2°	1.1	3	SL7M-1041	SL7M-1031	SL7M-1041	SL7M-1031
Lower Anterior	2 2	-11°	4°	1.1	3	SL7M-1042	SL7M-1032	SL7M-1042	SL7M-1032
Cuspid	3 3	0°	5°	0.8	3	SL7M-1143	SL7M-1133	SL7M-1043	SL7M-1033
1st Bicuspid	4 4	-12°	4°	0.8	3	SL7M-1144	SL7M-1134	SL7M-1044	SL7M-1034
2nd Bicuspid	5 5	-17°	4°	0.8	3	SL7M-1145	SL7M-1135	SL7M-1045	SL7M-1035

Full Kits ▲▼

20pcs/kit

Kits	package	no hook	3with hook	345with hook
.022	Low Torque	SL7M-01	SL7M-02	SL7M-03

MIM Series Brackets >> Self-Ligating Brackets 7G



7G

Proven patented sliding cover unlocking technology ensures the smooth opening and closing of the lock plate, improves the efficiency of wire replacement, and shortens the treatment cycle.

The rounder bracket shape gives the patient a more comfortable wearing experience.



The traction hook can be removed and adjusted mesial and distal.

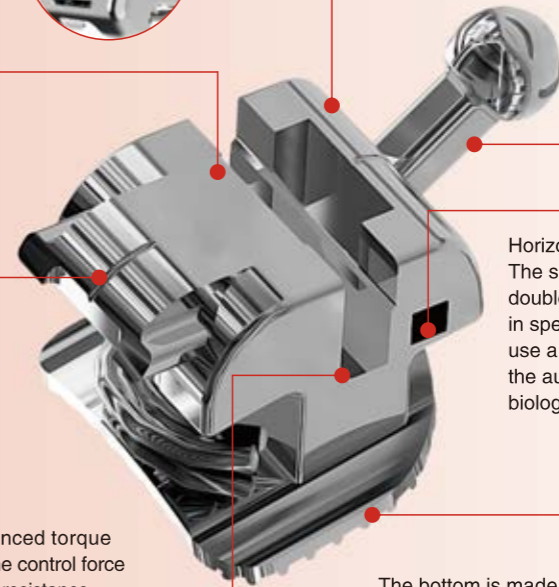

Central positioning line design can assist brackets bonding positioning.

Horizontal auxiliary slot
The size 0.42X0.42mm allows the double arch wire technique to be used in special cases(The physician can use a light force of arch wire through the auxiliary slot to maintain proper biological force).

Notch design for enhanced torque control strengthens the control force and reduces the friction resistance, separating as high torque, standard torque and low torque.

The bottom is made of 80 gauge mesh base and ultra-thin design, making adhesion and adsorption force stronger than other brackets.

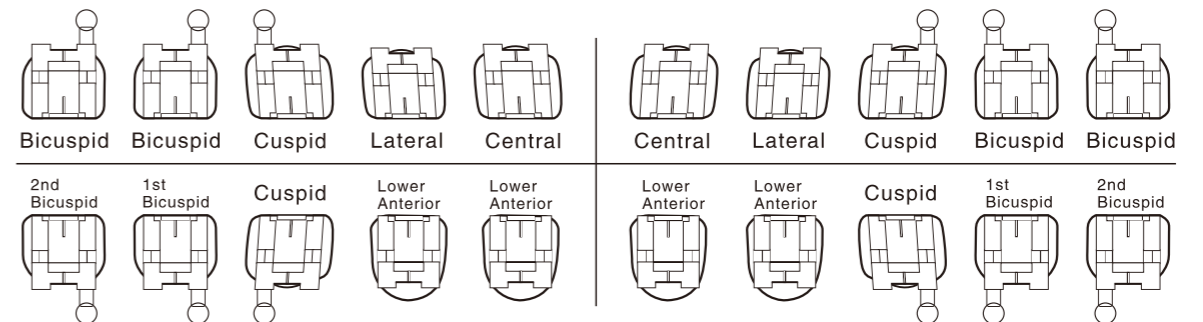

Self-Ligating Standard Torque Brackets 7G



MAXILLARY ▲	Torque	Angle	In/out	Width	0.022 with hook		0.022 no hook		
					R	L	R	L	
Central	1 1	15°	5°	0.9	2.8	SS72-1011	SS72-1021	SS72-1011	SS72-1021
Lateral	2 2	6°	9°	1.1	2.8	SS72-1012	SS72-1022	SS72-1012	SS72-1022
Cuspid	3 3	7°	5°	0.8	2.8	SS72-1113	SS72-1123	SS72-1013	SS72-1023
Bicuspid	4 4	-11°	2°	0.8	2.8	SS72-1114	SS72-1124	SS72-1014	SS72-1024
Bicuspid	5 5	-11°	2°	0.8	2.8	SS72-1115	SS72-1125	SS72-1015	SS72-1025

MANDIBULAR ▼	Torque	Angle	In/out	Width	0.022 with hook		0.022 no hook		
					R	L	R	L	
Lower Anterior	1 1	-3°	2°	1.1	2.8	SS72-1041	SS72-1031	SS72-1041	SS72-1031
Lower Anterior	2 2	-3°	4°	1.1	2.8	SS72-1042	SS72-1032	SS72-1042	SS72-1032
Cuspid	3 3	7°	5°	0.8	2.8	SS72-1143	SS72-1133	SS72-1043	SS72-1033
1st Bicuspid	4 4	-12°	4°	0.8	2.8	SS72-1144	SS72-1134	SS72-1044	SS72-1034
2nd Bicuspid	5 5	-17°	4°	0.8	2.8	SS72-1145	SS72-1135	SS72-1045	SS72-1035

Full Kits ▲▼

20pcs/kit

Kits	package	no hook	3with hook	345with hook
.022	Standard Torque	SS72-01	SS72-02	SS72-03

Self-Ligating High Torque Brackets 7G



MAXILLARY ▲	Torque	Angle	In/out	Width	0.022 with hook		0.022 no hook		
					R	L	R	L	
Central	1 1	22°	5°	0.9	2.8	SH72-1011	SH72-1021	SH72-1011	SH72-1021
Lateral	2 2	13°	9°	1.1	2.8	SH72-1012	SH72-1022	SH72-1012	SH72-1022
Cuspid	3 3	11°	5°	0.8	2.8	SH72-1113	SH72-1123	SH72-1013	SH72-1023
Bicuspid	4 4	-11°	2°	0.8	2.8	SH72-1114	SH72-1124	SH72-1014	SH72-1024
Bicuspid	5 5	-11°	2°	0.8	2.8	SH72-1115	SH72-1125	SH72-1015	SH72-1025

MANDIBULAR ▼	Torque	Angle	In/out	Width	0.022 with hook		0.022 no hook		
					R	L	R	L	
Lower Anterior	1 1	-3°	2°	1.1	2.8	SH72-1041	SH72-1031	SH72-1041	SH72-1031
Lower Anterior	2 2	-3°	4°	1.1	2.8	SH72-1042	SH72-1032	SH72-1042	SH72-1032
Cuspid	3 3	7°	5°	0.8	2.8	SH72-1143	SH72-1133	SH72-1043	SH72-1033
1st Bicuspid	4 4	-12°	4°	0.8	2.8	SH72-1144	SH72-1134	SH72-1044	SH72-1034
2nd Bicuspid	5 5	-17°	4°	0.8	2.8	SH72-1145	SH72-1135	SH72-1045	SH72-1035

Full Kits ▲▼

20pcs/kit

Kits	package	no hook	3with hook	345with hook
.022	High Torque	SH72-01	SH72-02	SH72-03

Self-Ligating Low Torque Brackets 7G



MAXILLARY ▲	Torque	Angle	In/out	Width	0.022 with hook		0.022 no hook		
					R	L	R	L	
Central	1 1	2°	5°	0.9	2.8	SL72-1011	SL72-1021	SL72-1011	SL72-1021
Lateral	2 2	-5°	9°	1.1	2.8	SL72-1012	SL72-1022	SL72-1012	SL72-1022
Cuspid	3 3	-9°	5°	0.8	2.8	SL72-1113	SL72-1123	SL72-1013	SL72-1023
Bicuspid	4 4	-11°	2°	0.8	2.8	SL72-1114	SL72-1124	SL72-1014	SL72-1024
Bicuspid	5 5	-11°	2°	0.8	2.8	SL72-1115	SL72-1125	SL72-1015	SL72-1025

MANDIBULAR ▼	Torque	Angle	In/out	Width	0.022 with hook		0.022 no hook		
					R	L	R	L	
Lower Anterior	1 1	-11°	2°	1.1	2.8	SL72-1041	SL72-1031	SL72-1041	SL72-1031
Lower Anterior	2 2	-11°	4°	1.1	2.8	SL72-1042	SL72-1032	SL72-1042	SL72-1032
Cuspid	3 3	0°	5°	0.8	2.8	SL72-1143	SL72-1133	SL72-1043	SL72-1033
1st Bicuspid	4 4	-12°	4°	0.8	2.8	SL72-1144	SL72-1134	SL72-1044	SL72-1034
2nd Bicuspid	5 5	-17°	4°	0.8	2.8	SL72-1145	SL72-1135	SL72-1045	SL72-1035

Full Kits ▲▼

20pcs/kit

Kits	package	no hook	3with hook	345with hook
.022	Low Torque	SL72-01	SL72-02	SL72-03

MIM Series Brackets >> Self-Ligating Brackets 5G Plus

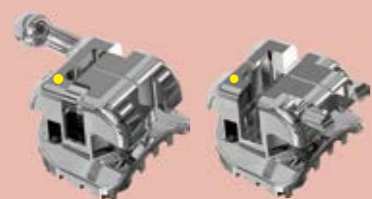

5G Plus

Highly cost-effective brackets that balance quality and affordability

Precise Positioning

Light force orthodontic treatment

The ultra-thin, ergonomic design ensures maximum patient comfort and a less intrusive feel during treatment

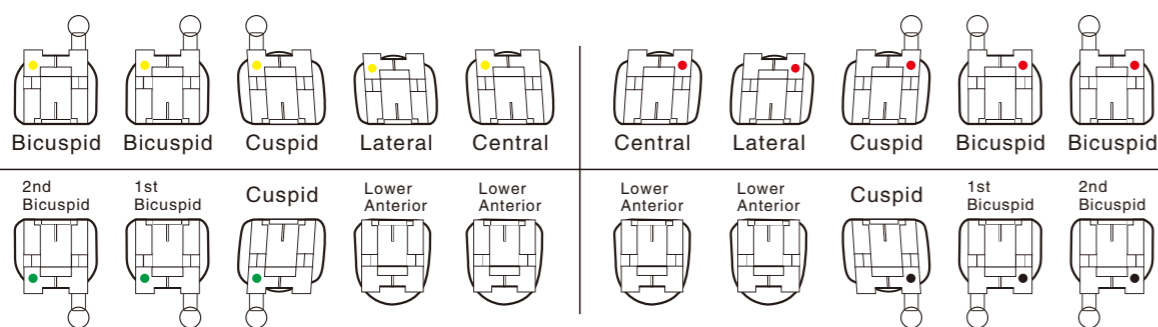
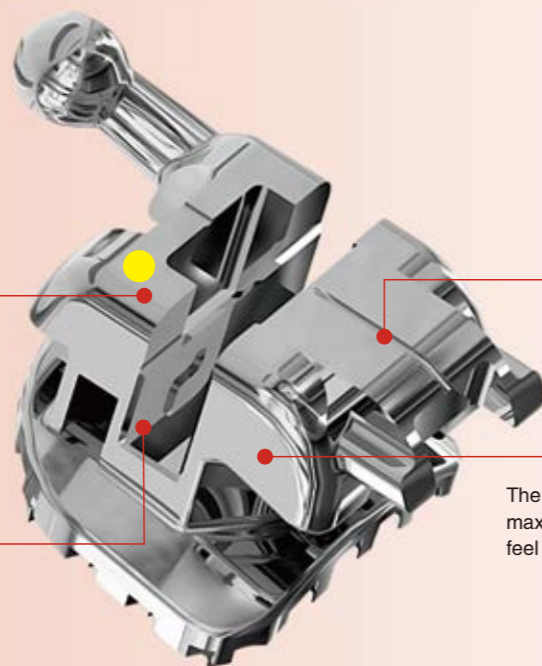

Self-Ligating Roth Brackets 5G Plus



MAXILLARY ▲	Torque	Angle	In/out	Width	0.022 with hook		0.022 no hook		
					R	L	R	L	
Central	1 1	12°	5°	0.7	3.1	SZ52-1011P	SZ52-1021P	SZ52-1011P	SZ52-1021P
Lateral	2 2	8°	9°	1.1	2.8	SZ52-1012P	SZ52-1022P	SZ52-1012P	SZ52-1022P
Cuspid	3 3	-2°	11°	0.7	3.1	SZ52-1113P	SZ52-1123P	SZ52-1013P	SZ52-1023P
Bicuspid	4 4	-7°	0°	0.7	2.9	SZ52-1114P	SZ52-1124P	SZ52-1014P	SZ52-1024P
Bicuspid	5 5	-7°	0°	0.7	2.9	SZ52-1115P	SZ52-1125P	SZ52-1015P	SZ52-1025P

MANDIBULAR ▼	Torque	Angle	In/out	Width	0.022 with hook		0.022 no hook		
					R	L	R	L	
Lower Anterior	1 1	-1°	0°	1.1	2.75	SZ52-1041P	SZ52-1031P	SZ52-1041P	SZ52-1031P
Lower Anterior	2 2	-1°	0°	1.1	2.75	SZ52-1042P	SZ52-1032P	SZ52-1042P	SZ52-1032P
Cuspid	3 3	-11°	5°	0.7	3.1	SZ52-1143P	SZ52-1133P	SZ52-1043P	SZ52-1033P
1st Bicuspid	4 4	-17°	0°	0.7	2.9	SZ52-1144P	SZ52-1134P	SZ52-1044P	SZ52-1034P
2nd Bicuspid	5 5	-22°	0°	0.7	2.9	SZ52-1145P	SZ52-1135P	SZ52-1045P	SZ52-1035P

Full Kits ▲▼

20pcs/kit

Kits	package	no hook	3with hook	345with hook
.022	no laser mark	SZ52-01P	SZ52-02P	SZ52-03P

Self-Ligating MBT Brackets 5G Plus



MAXILLARY ▲	Torque	Angle	In/out	Width	0.022 with hook		0.022 no hook		
					R	L	R	L	
Central	1 1	17°	4°	0.9	3.1	SM52-1011P	SM52-1021P	SM52-1011P	SM52-1021P
Lateral	2 2	10°	8°	1.1	2.8	SM52-1012P	SM52-1022P	SM52-1012P	SM52-1022P
Cuspid	3 3	0°	8°	0.8	3.1	SM52-1113P	SM52-1123P	SM52-1013P	SM52-1023P
Bicuspid	4 4	-7°	0°	0.8	2.9	SM52-1114P	SM52-1124P	SM52-1014P	SM52-1024P
Bicuspid	5 5	-7°	0°	0.8	2.9	SM52-1115P	SM52-1125P	SM52-1015P	SM52-1025P

MANDIBULAR ▼	Torque	Angle	In/out	Width	0.022 with hook		0.022 no hook		
					R	L	R	L	
Lower Anterior	1 1	-6°	0°	1.1	2.75	SM52-1041P	SM52-1031P	SM52-1041P	SM52-1031P
Lower Anterior	2 2	-6°	0°	1.1	2.75	SM52-1042P	SM52-1032P	SM52-1042P	SM52-1032P
Cuspid	3 3	0°	3°	0.8	3.1	SM52-1143P	SM52-1133P	SM52-1043P	SM52-1033P
1st Bicuspid	4 4	-12°	2°	0.8	2.9	SM52-1144P	SM52-1134P	SM52-1044P	SM52-1034P
2nd Bicuspid	5 5	-17°	2°	0.8	2.9	SM52-1145P	SM52-1135P	SM52-1045P	SM52-1035P

Full Kits ▲▼

20pcs/kit

Kits	package	no hook	3with hook	345with hook
.022	no laser mark	SM52-01P	SM52-02P	SM52-03P

MIM Series Brackets >> Self-Ligating Brackets 5G



Central positioning line design can assist brackets bonding positioning

Horizontal Auxiliary Slot
The 0.42 x 0.42 mm slot allows for double archwire techniques and light-force control, enhancing treatment precision in complex cases

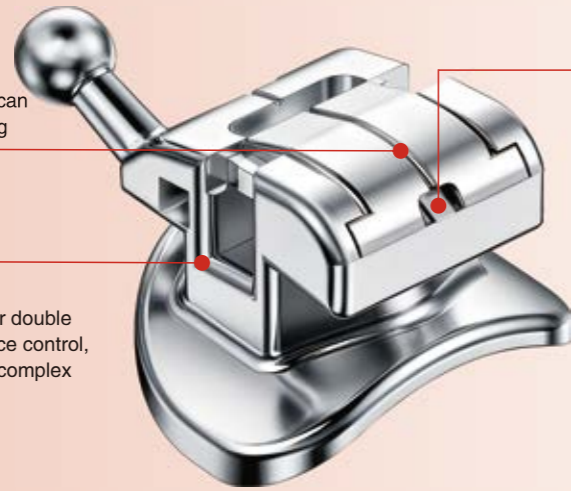

Proven patented sliding cover unlocking technology ensures the smooth opening and closing of the lock plate, improves the efficiency of wire replacement, and shortens the treatment cycle

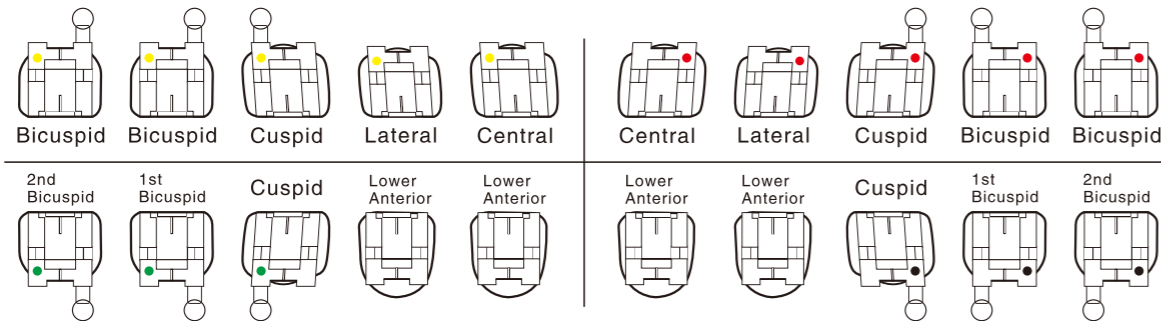

Self-Ligating Roth Brackets 5G



MAXILLARY ▲	Torque	Angle	In/out	Width	0.022 with hook		0.022 no hook		
					R	L	R	L	
Central	1 1	12°	5°	0.7	3.1	SZ52-1011	SZ52-1021	SZ52-1011	SZ52-1021
Lateral	2 2	8°	9°	1.1	2.8	SZ52-1012	SZ52-1022	SZ52-1012	SZ52-1022
Cuspid	3 3	-2°	11°	0.7	3.1	SZ52-1113	SZ52-1123	SZ52-1013	SZ52-1023
Bicuspid	4 4	-7°	0°	0.7	2.9	SZ52-1114	SZ52-1124	SZ52-1014	SZ52-1024
Bicuspid	5 5	-7°	0°	0.7	2.9	SZ52-1115	SZ52-1125	SZ52-1015	SZ52-1025

MANDIBULAR ▼	Torque	Angle	In/out	Width	0.022 with hook		0.022 no hook		
					R	L	R	L	
Lower Anterior	1 1	-1°	0°	1.1	2.75	SZ52-1041	SZ52-1031	SZ52-1041	SZ52-1031
Lower Anterior	2 2	-1°	0°	1.1	2.75	SZ52-1042	SZ52-1032	SZ52-1042	SZ52-1032
Cuspid	3 3	-11°	5°	0.7	3.1	SZ52-1143	SZ52-1133	SZ52-1043	SZ52-1033
1st Bicuspid	4 4	-17°	0°	0.7	2.9	SZ52-1144	SZ52-1134	SZ52-1044	SZ52-1034
2nd Bicuspid	5 5	-22°	0	0.7	2.9	SZ52-1145	SZ52-1135	SZ52-1045	SZ52-1035

Full Kits ▲▼

20pcs/kit

Kits	package	no hook	3with hook	345with hook
.022	with laser mark	SZ52-11	SZ52-12	SZ52-13
	no laser mark	SZ52-01	SZ52-02	SZ52-03

Self-Ligating MBT Brackets 5G



MAXILLARY ▲	Torque	Angle	In/out	Width	0.022 with hook		0.022 no hook		
					R	L	R	L	
Central	1 1	17°	4°	0.9	3.1	SM52-1011	SM52-1021	SM52-1011	SM52-1021
Lateral	2 2	10°	8°	1.1	2.8	SM52-1012	SM52-1022	SM52-1012	SM52-1022
Cuspid	3 3	0°	8°	0.8	3.1	SM52-1113	SM52-1123	SM52-1013	SM52-1023
Bicuspid	4 4	-7°	0°	0.8	2.9	SM52-1114	SM52-1124	SM52-1014	SM52-1024
Bicuspid	5 5	-7°	0°	0.8	2.9	SM52-1115	SM52-1125	SM52-1015	SM52-1025

MANDIBULAR ▼	Torque	Angle	In/out	Width	0.022 with hook		0.022 no hook		
					R	L	R	L	
Lower Anterior	1 1	-6°	0°	1.1	2.75	SM52-1041	SM52-1031	SM52-1041	SM52-1031
Lower Anterior	2 2	-6°	0°	1.1	2.75	SM52-1042	SM52-1032	SM52-1042	SM52-1032
Cuspid	3 3	0°	3°	0.8	3.1	SM52-1143	SM52-1133	SM52-1043	SM52-1033
1st Bicuspid	4 4	-12°	2°	0.8	2.9	SM52-1144	SM52-1134	SM52-1044	SM52-1034
2nd Bicuspid	5 5	-17°	2°	0.8	2.9	SM52-1145	SM52-1135	SM52-1045	SM52-1035

Full Kits ▲▼

20pcs/kit

Kits	package	no hook	3with hook	345with hook
.022	with laser mark	SM52-11	SM52-12	SM52-13
	no laser mark	SM52-01	SM52-02	SM52-03

MIM Series Brackets >> Self-Ligating Brackets 3G

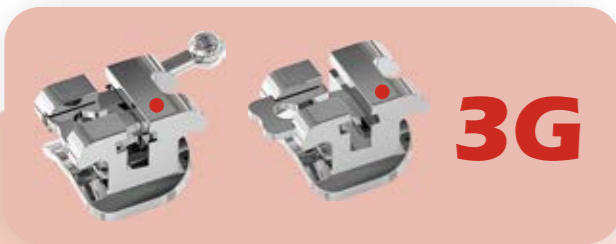

The bracket is made of ultra-thin design to minimize the thickness of the brackets and prevent bite interference during treatment.

The lock plate is made of nickel-titanium material, which has high strength, good elasticity, and is not easy to wear and tear. It is convenient to open the cover and has a long service life.

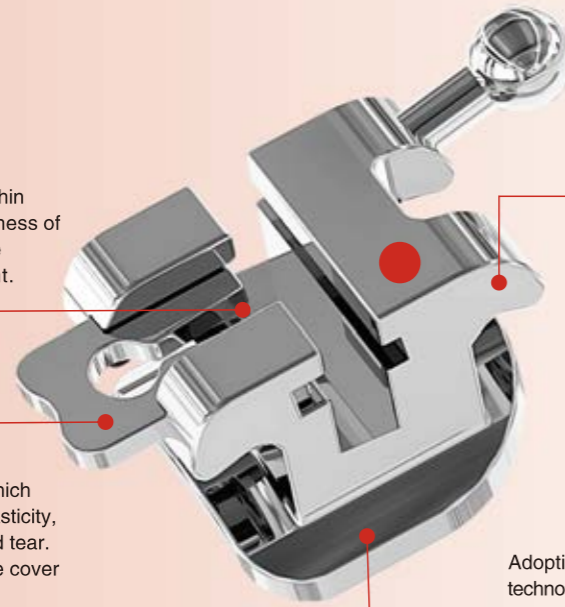

The rounded corners of the brackets are smoothed to improve patient comfort and make the product more beautiful.

Adopting the latest 80 gauge mesh base technology makes the brackets more adhesive

Self-Ligating Roth Brackets 3G



MAXILLARY ▲	Torque	Angle	In/out	Width	0.018 with hook		0.018 no hook		0.022 with hook		0.022 no hook		
					R	L	R	L	R	L	R	L	
Central	1 1	12°	5°	0.7	3.2	SZ11-1011	SZ11-1021	SZ11-1011	SZ11-1021	SZ12-1011	SZ12-1021	SZ12-1011	SZ12-1021
Lateral	2 2	8°	9°	1.05	2.9	SZ11-1012	SZ11-1022	SZ11-1012	SZ11-1022	SZ12-1012	SZ12-1022	SZ12-1012	SZ12-1022
Cuspid	3 3	-2°	11°	0.7	3.1	SZ11-1113	SZ11-1123	SZ11-1013	SZ11-1023	SZ12-1113	SZ12-1123	SZ12-1013	SZ12-1023
Bicuspid	4,5 4,5	-7°	0°	0.7	2.9	SZ11-1114	SZ11-1124	SZ11-1014	SZ11-1024	SZ12-1114	SZ12-1124	SZ12-1014	SZ12-1024

MANDIBULAR ▼	Torque	Angle	In/out	Width	0.018 with hook		0.018 no hook		0.022 with hook		0.022 no hook		
					R	L	R	L	R	L	R	L	
Lower Anterior	1,2 1,2	-1°	0°	0.9	2.7	SZ11-1041	SZ11-1031	SZ11-1041	SZ11-1031	SZ12-1041	SZ12-1031	SZ12-1041	SZ12-1031
Cuspid	3 3	-11°	5°	0.7	3.1	SZ11-1143	SZ11-1133	SZ11-1043	SZ11-1033	SZ12-1143	SZ12-1133	SZ12-1043	SZ12-1033
1st Bicuspid	4 4	-17°	0°	0.7	2.9	SZ11-1144	SZ11-1134	SZ11-1044	SZ11-1034	SZ12-1144	SZ12-1134	SZ12-1044	SZ12-1034
2nd Bicuspid	5 5	-22°	0°	0.7	2.9	SZ11-1145	SZ11-1135	SZ11-1045	SZ11-1035	SZ12-1145	SZ12-1135	SZ12-1045	SZ12-1035

Full Kits ▲▼

20pcs/kit

Kits	package	no hook	3with hook	345with hook
.018	with laser mark	SZ11-11	SZ11-12	SZ11-13
	no laser mark	SZ11-01	SZ11-02	SZ11-03
.022	with laser mark	SZ12-11	SZ12-12	SZ12-13
	no laser mark	SZ12-01	SZ12-02	SZ12-03

Self-Ligating MBT Brackets 3G



MAXILLARY ▲	Torque	Angle	In/out	Width	0.018 with hook		0.018 no hook		0.022 with hook		0.022 no hook		
					R	L	R	L	R	L	R	L	
Central	1 1	17°	4°	0.7	3.2	SM11-1011	SM11-1021	SM11-1011	SM11-1021	SM12-1011	SM12-1021	SM12-1011	SM12-1021
Lateral	2 2	10°	8°	1.05	2.9	SM11-1012	SM11-1022	SM11-1012	SM11-1022	SM12-1012	SM12-1022	SM12-1012	SM12-1022
Cuspid	3 3	0°	8°	0.7	3.1	SM11-1113	SM11-1123	SM11-1013	SM11-1023	SM12-1113	SM12-1123	SM12-1013	SM12-1023
Bicuspid	4,5 4,5	-7°	0°	0.7	2.9	SM11-1114	SM11-1124	SM11-1014	SM11-1024	SM12-1114	SM12-1124	SM12-1014	SM12-1024

MANDIBULAR ▼	Torque	Angle	In/out	Width	0.018 with hook		0.018 no hook		0.022 with hook		0.022 no hook		
					R	L	R	L	R	L	R	L	
Lower Anterior	1,2 1,2	-6°	0°	0.9	2.7	SM11-1041	SM11-1031	SM11-1041	SM11-1031	SM12-1041	SM12-1031	SM12-1041	SM12-1031
Cuspid	3 3	0°	3°	0.7	3.1	SM11-1143	SM11-1133	SM11-1043	SM11-1033	SM12-1143	SM12-1133	SM12-1043	SM12-1033
1st Bicuspid	4 4	-12°	2°	0.7	2.9	SM11-1144	SM11-1134	SM11-1044	SM11-1034	SM12-1144	SM12-1134	SM12-1044	SM12-1034
2nd Bicuspid	5 5	-17°	2°	0.7	2.9	SM11-1145	SM11-1135	SM11-1045	SM11-1035	SM12-1145	SM12-1135	SM12-1045	SM12-1035

Full Kits ▲▼

20pcs/kit

Kits	package	no hook	3with hook	345with hook
.018	with laser mark	SM11-11	SM11-12	SM11-13
	no laser mark	SM11-01	SM11-02	SM11-03
.022	with laser mark	SM12-11	SM12-12	SM12-13
	no laser mark	SM12-01	SM12-02	SM12-03

MIM Series Brackets >> Active Self-Ligating Brackets MA1



MA1

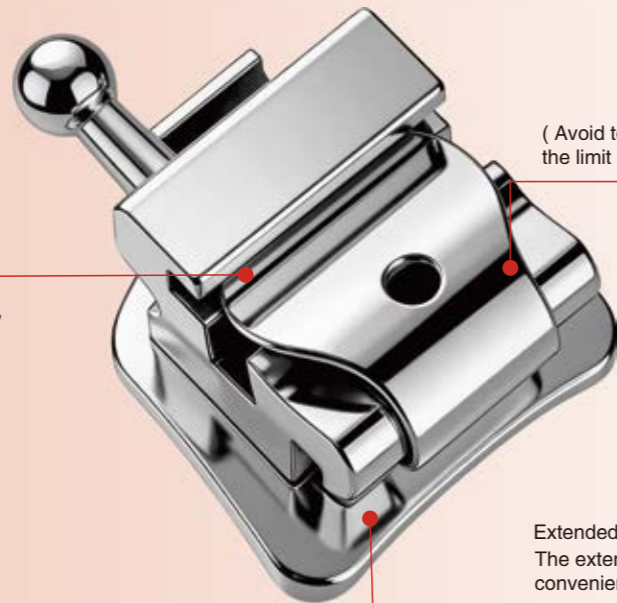

Easy and quick wire changes, improving clinical efficiency.

(Avoid to press the lip inward) the clip opens, the limit end will prevent clip from pulling out.

Extended Ligature Wings
The extension of tie wings to achieve more convenient and revise ligation methods.

Active Self-Ligating Roth Brackets MA1



MAXILLARY ▲	Torque	Angle	In/out	Width	0.018 with hook		0.018 no hook		0.022 with hook		0.022 no hook		
					R	L	R	L	R	L	R	L	
Central	1 1	12°	5°	0.8	2.96	SZA1-1011	SZA1-1021	SZA1-1011	SZA1-1021	SZA2-1011	SZA2-1021	SZA2-1011	SZA2-1021
Lateral	2 2	8°	9°	1.1	2.62	SZA1-1012	SZA1-1022	SZA1-1012	SZA1-1022	SZA2-1012	SZA2-1022	SZA2-1012	SZA2-1022
Cuspid	3 3	-2°	11°	0.8	2.82	SZA1-1113	SZA1-1123	SZA1-1013	SZA1-1023	SZA2-1113	SZA2-1123	SZA2-1013	SZA2-1023
Bicuspid	4,5 4,5	-7°	0°	0.8	2.75	SZA1-1114	SZA1-1124	SZA1-1014	SZA1-1024	SZA2-1114	SZA2-1124	SZA2-1014	SZA2-1024

MANDIBULAR ▼	Torque	Angle	In/out	Width	0.018 with hook		0.018 no hook		0.022 with hook		0.022 no hook		
					R	L	R	L	R	L	R	L	
Lower Anterior	1,2 1,2	-1°	0°	0.9	2.53	SZA1-1041	SZA1-1031	SZA1-1041	SZA1-1031	SZA2-1041	SZA2-1031	SZA2-1041	SZA2-1031
Cuspid	3 3	-11°	5°	0.8	2.71	SZA1-1143	SZA1-1133	SZA1-1043	SZA1-1033	SZA2-1143	SZA2-1133	SZA2-1043	SZA2-1033
1st Bicuspid	4 4	-17°	0°	0.8	2.74	SZA1-1144	SZA1-1134	SZA1-1044	SZA1-1034	SZA2-1144	SZA2-1134	SZA2-1044	SZA2-1034
2nd Bicuspid	5 5	-22°	0°	0.8	2.74	SZA1-1145	SZA1-1135	SZA1-1045	SZA1-1035	SZA2-1145	SZA2-1135	SZA2-1045	SZA2-1035

Full Kits ▲▼

20pcs/kit

Kits	package	no hook	3with hook	345with hook
.018	with laser mark	SZA1-11	SZA1-12	SZA1-13
	no laser mark	SZA1-01	SZA1-02	SZA1-03
.022	with laser mark	SZA2-11	SZA2-12	SZA2-13
	no laser mark	SZA2-01	SZA2-02	SZA2-03

Active Self-Ligating MBT Brackets MA1



MAXILLARY ▲	Torque	Angle	In/out	Width	0.018 with hook		0.018 no hook		0.022 with hook		0.022 no hook		
					R	L	R	L	R	L	R	L	
Central	1 1	17°	4°	0.8	2.96	SMA1-1011	SMA1-1021	SMA1-1011	SMA1-1021	SMA2-1011	SMA2-1021	SMA2-1011	SMA2-1021
Lateral	2 2	10°	8°	1.1	2.62	SMA1-1012	SMA1-1022	SMA1-1012	SMA1-1022	SMA2-1012	SMA2-1022	SMA2-1012	SMA2-1022
Cuspid	3 3	0°	8°	0.8	2.82	SMA1-1113	SMA1-1123	SMA1-1013	SMA1-1023	SMA2-1113	SMA2-1123	SMA2-1013	SMA2-1023
Bicuspid	4,5 4,5	-7°	0°	0.8	2.75	SMA1-1114	SMA1-1124	SMA1-1014	SMA1-1024	SMA2-1114	SMA2-1124	SMA2-1014	SMA2-1024

MANDIBULAR ▼	Torque	Angle	In/out	Width	0.018 with hook		0.018 no hook		0.022 with hook		0.022 no hook		
					R	L	R	L	R	L	R	L	
Lower Anterior	1,2 1,2	-6°	0°	0.9	2.53	SMA1-1041	SMA1-1031	SMA1-1041	SMA1-1031	SMA2-1041	SMA2-1031	SMA2-1041	SMA2-1031
Cuspid	3 3	0°	3°	0.8	2.71	SMA1-1143	SMA1-1133	SMA1-1043	SMA1-1033	SMA2-1143	SMA2-1133	SMA2-1043	SMA2-1033
1st Bicuspid	4 4	-12°	2°	0.8	2.74	SMA1-1144	SMA1-1134	SMA1-1044	SMA1-1034	SMA2-1144	SMA2-1134	SMA2-1044	SMA2-1034
2nd Bicuspid	5 5	-17°	2°	0.8	2.74	SMA1-1145	SMA1-1135	SMA1-1045	SMA1-1035	SMA2-1145	SMA2-1135	SMA2-1045	SMA2-1035

Full Kits ▲▼

20pcs/kit

Kits	package	no hook	3with hook	345with hook
.018	with laser mark	SMA1-11	SMA1-12	SMA1-13
	no laser mark	SMA1-01	SMA1-02	SMA1-03
.022	with laser mark	SMA2-11	SMA2-12	SMA2-13
	no laser mark	SMA2-01	SMA2-02	SMA2-03

MIM Series Brackets >> Active Self Ligating Bracket MA2



MA2

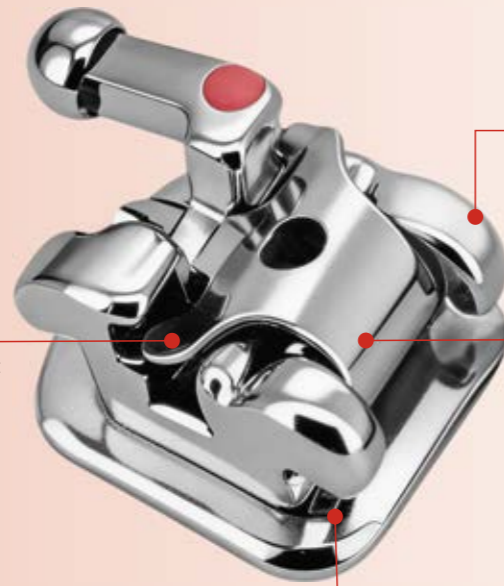

Low-profile design enhances patient comfort

No ligatures simplifies clinical workflow efficiency

Nickel-titanium clip, light-force treatment

Low friction enables faster tooth movement

Active Self-Ligating Roth Brackets MA2



MAXILLARY ▲	Torque	Angle	In/out	Width	0.018 with hook		0.018 no hook		0.022 with hook		0.022 no hook		
					R	L	R	L	R	L	R	L	
Central	1 1	12°	5°	0.7	2.8	SZA3-1011	SZA3-1021	SZA3-1011	SZA3-1021	SZA4-1011	SZA4-1021	SZA4-1011	SZA4-1021
Lateral	2 2	8°	9°	0.7	2.8	SZA3-1012	SZA3-1022	SZA3-1012	SZA3-1022	SZA4-1012	SZA4-1022	SZA4-1012	SZA4-1022
Cuspid	3 3	-2°	11°	0.7	2.8	SZA3-1113	SZA3-1123	SZA3-1013	SZA3-1023	SZA4-1113	SZA4-1123	SZA4-1013	SZA4-1023
Bicuspid	4,5 4,5	-7°	0°	0.7	2.8	SZA3-1114	SZA3-1124	SZA3-1014	SZA3-1024	SZA4-1114	SZA4-1124	SZA4-1014	SZA4-1024
MANDIBULAR ▼	Torque	Angle	In/out	Width	0.018 with hook		0.018 no hook		0.022 with hook		0.022 no hook		
Lower Anterior	1,2 1,2	-1°	0°	0.7	2.8	SZA3-1041	SZA3-1031	SZA3-1041	SZA3-1031	SZA4-1041	SZA4-1031	SZA4-1041	SZA4-1031
Cuspid	3 3	-11°	5°	0.7	2.8	SZA3-1043	SZA3-1133	SZA3-1043	SZA3-1033	SZA4-1043	SZA4-1133	SZA4-1043	SZA4-1033
1st Bicuspid	4 4	-17°	0°	0.7	2.8	SZA3-1144	SZA3-1134	SZA3-1044	SZA3-1034	SZA4-1144	SZA4-1134	SZA4-1044	SZA4-1034
2nd Bicuspid	5 5	-22°	0°	0.7	2.8	SZA3-1145	SZA3-1135	SZA3-1045	SZA3-1035	SZA4-1145	SZA4-1135	SZA4-1045	SZA4-1035

Full Kits ▲▼

20pcs/kit

Kits	package	no hook	3with hook	345with hook
.018	with laser mark	SZA3-11	SZA3-12	SZA3-13
	no laser mark	SZA3-01	SZA3-02	SZA3-03
.022	with laser mark	SZA4-11	SZA4-12	SZA4-13
	no laser mark	SZA4-01	SZA4-02	SZA4-03

Active Self-Ligating MBT Brackets MA2



MAXILLARY ▲	Torque	Angle	In/out	Width	0.018 with hook		0.018 no hook		0.022 with hook		0.022 no hook		
					R	L	R	L	R	L	R	L	
Central	1 1	17°	4°	0.7	2.8	SZA3-1011	SZA3-1021	SZA3-1011	SZA3-1021	SZA4-1011	SZA4-1021	SZA4-1011	SZA4-1021
Lateral	2 2	10°	8°	0.7	2.8	SZA3-1012	SZA3-1022	SZA3-1012	SZA3-1022	SZA4-1012	SZA4-1022	SZA4-1012	SZA4-1022
Cuspid	3 3	0°	8°	0.7	2.8	SZA3-1113	SZA3-1123	SZA3-1013	SZA3-1023	SZA4-1113	SZA4-1123	SZA4-1013	SZA4-1023
Bicuspid	4,5 4,5	-7°	0°	0.7	2.8	SZA3-1114	SZA3-1124	SZA3-1014	SZA3-1024	SZA4-1114	SZA4-1124	SZA4-1014	SZA4-1024
MANDIBULAR ▼	Torque	Angle	In/out	Width	0.018 with hook		0.018 no hook		0.022 with hook		0.022 no hook		
Lower Anterior	1,2 1,2	-6°	0°	0.9	2.53	SZA3-1041	SZA3-1031	SZA3-1041	SZA3-1031	SZA4-1041	SZA4-1031	SZA4-1041	SZA4-1031
Cuspid	3 3	0°	3°	0.8	2.71	SZA3-1143	SZA3-1133	SZA3-1043	SZA3-1033	SZA4-1143	SZA4-1133	SZA4-1043	SZA4-1033
1st Bicuspid	4 4	-12°	2°	0.8	2.74	SZA3-1144	SZA3-1134	SZA3-1044	SZA3-1034	SZA4-1144	SZA4-1134	SZA4-1044	SZA4-1034
2nd Bicuspid	5 5	-17°	2°	0.8	2.74	SZA3-1145	SZA3-1135	SZA3-1045	SZA3-1035	SZA4-1145	SZA4-1135	SZA4-1045	SZA4-1035

Full Kits ▲▼

20pcs/kit

Kits	package	no hook	3with hook	345with hook
.018	with laser mark	SMA3-11	SMA3-12	SMA3-13
	no laser mark	SMA3-01	SMA3-02	SMA3-03
.022	with laser mark	SMA4-11	SMA4-12	SMA4-13
	no laser mark	SMA4-01	SMA4-02	SMA4-03

MIM Series Brackets >> Mini&Standard Brackets

The clear central axis, precise torque, angulations and slot size. Makes it easier for doctors to operate, and the mini-bracket is comfortable for patients to wear.

Accurate product size, ultra-high precision, and smooth surface greatly reduce oral mucosal irritation.

Adopting advanced MIM production technology, high-quality medical stainless steel materials, fine processing, and precision molds to ensure product consistency.

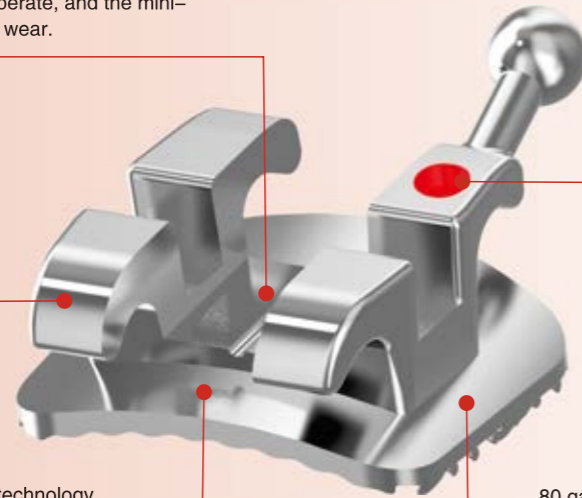

Removable color coded ID dot, for easy brackets selection.

80 gauge mesh base bottom and ultra-thin design make brackets have stronger adhesion and adsorption. Advanced welding technology, never drop from the pad when bonding.

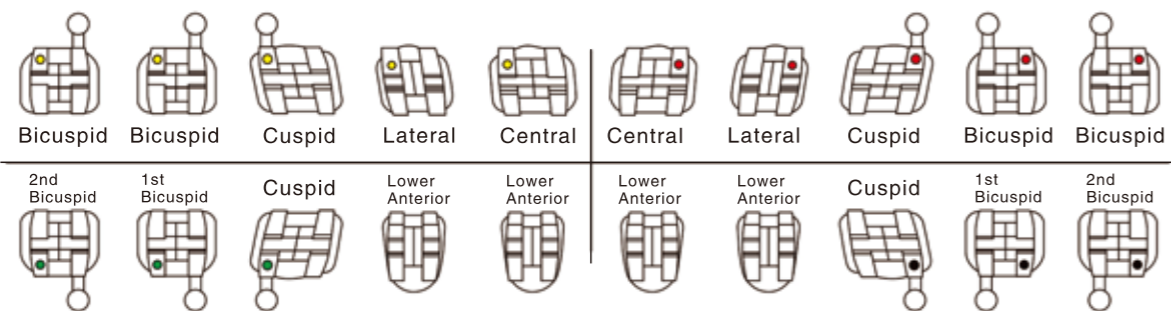

MIM Mini Roth Brackets



MAXILLARY ▲	Torque	Angle	In/out	Width	0.018 with hook		0.018 no hook		0.022 with hook		0.022 no hook		
					R	L	R	L	R	L	R	L	
Central	1 1	12°	5°	0.8	3	TZ51-1011	TZ51-1021	TZ51-1011	TZ51-1021	TZ52-1011	TZ52-1021	TZ52-1011	TZ52-1021
Lateral	2 2	8°	9°	1.18	2.8	TZ51-1012	TZ51-1022	TZ51-1012	TZ51-1022	TZ52-1012	TZ52-1022	TZ52-1012	TZ52-1022
Cuspid	3 3	-2°	11°	0.8	3	TZ51-1113	TZ51-1123	TZ51-1013	TZ51-1023	TZ52-1113	TZ52-1123	TZ52-1013	TZ52-1023
Bicuspid	4,5 4,5	-7°	0°	0.8	2.8	TZ51-1114	TZ51-1124	TZ51-1014	TZ51-1024	TZ52-1114	TZ52-1124	TZ52-1014	TZ52-1024

MANDIBULAR ▼	Torque	Angle	In/out	Width	0.018 with hook		0.018 no hook		0.022 with hook		0.022 no hook		
					R	L	R	L	R	L	R	L	
Lower Anterior	1,2 1,2	-1°	0°	1.18	2.4	TZ51-1041	TZ51-1031	TZ51-1041	TZ51-1031	TZ52-1041	TZ52-1031	TZ52-1041	TZ52-1031
Cuspid	3 3	-11°	5°	0.8	2.8	TZ51-1143	TZ51-1133	TZ51-1043	TZ51-1033	TZ52-1143	TZ52-1133	TZ52-1043	TZ52-1033
1st Bicuspid	4 4	-17°	0°	0.8	2.8	TZ51-1144	TZ51-1134	TZ51-1044	TZ51-1034	TZ52-1144	TZ52-1134	TZ52-1044	TZ52-1034
2nd Bicuspid	5 5	-22°	0°	0.8	2.8	TZ51-1145	TZ51-1135	TZ51-1045	TZ51-1035	TZ52-1145	TZ52-1135	TZ52-1045	TZ52-1035

Full Kits ▲▼

20pcs/kit

Kits	package	no hook	3with hook	345with hook
.018	with laser mark	TZ51-11	TZ51-12	TZ51-13
	no laser mark	TZ51-01	TZ51-02	TZ51-03
.022	with laser mark	TZ52-11	TZ52-12	TZ52-13
	no laser mark	TZ52-01	TZ52-02	TZ52-03

MIM Mini MBT Brackets



MAXILLARY ▲	Torque	Angle	In/out	Width	0.018 with hook		0.018 no hook		0.022 with hook		0.022 no hook		
					R	L	R	L	R	L	R	L	
Central	1 1	17°	4°	0.7	3.1	TM51-1011	TM51-1021	TM51-1011	TM51-1021	TM52-1011	TM52-1021	TM52-1011	TM52-1021
Lateral	2 2	10°	8°	1.08	2.8	TM51-1012	TM51-1022	TM51-1012	TM51-1022	TM52-1012	TM52-1022	TM52-1012	TM52-1022
Cuspid	3 3	0°	8°	0.7	2.8	TM51-1113	TM51-1123	TM51-1013	TM51-1023	TM52-1113	TM52-1123	TM52-1013	TM52-1023
Bicuspid	4,5 4,5	-7°	0°	0.7	2.8	TM51-1114	TM51-1124	TM51-1014	TM51-1024	TM52-1114	TM52-1124	TM52-1014	TM52-1024

MANDIBULAR ▼	Torque	Angle	In/out	Width	0.018 with hook		0.018 no hook		0.022 with hook		0.022 no hook		
					R	L	R	L	R	L	R	L	
Lower Anterior	1,2 1,2	-6°	0°	0.9	2.2	TM51-1041	TM51-1031	TM51-1041	TM51-1031	TM52-1041	TM52-1031	TM52-1041	TM52-1031
Cuspid	3 3	0°	3°	0.7	2.8	TM51-1143	TM51-1133	TM51-1043	TM51-1033	TM52-1143	TM52-1133	TM52-1043	TM52-1033
1st Bicuspid	4 4	-12°	2°	0.7	2.8	TM51-1144	TM51-1134	TM51-1044	TM51-1034	TM52-1144	TM52-1134	TM52-1044	TM52-1034
2nd Bicuspid	5 5	-17°	2°	0.7	2.8	TM51-1145	TM51-1135	TM51-1045	TM51-1035	TM52-1145	TM52-1135	TM52-1045	TM52-1035

Full Kits ▲▼

20pcs/kit

Kits	package	no hook	3with hook	345with hook
.018	with laser mark	TM51-11	TM51-12	TM51-13
	no laser mark	TM51-01	TM51-02	TM51-03
.022	with laser mark	TM52-11	TM52-12	TM52-13
	no laser mark	TM52-01	TM52-02	TM52-03

MIM Mini Edgewise Brackets



MAXILLARY ▲	Torque	Angle	In/out	Width	0.018 with hook		0.018 no hook		0.022 with hook		0.022 no hook		
					R	L	R	L	R	L	R	L	
Central	1 1	0°	0°	0.7	3	TF51-1011	TF51-1021	TF51-1011	TF51-1021	TF52-1011	TF52-1021	TF52-1011	TF52-1021
Lateral	2 2	0°	0°	0.7	2.7	TF51-1012	TF51-1022	TF51-1012	TF51-1022	TF52-1012	TF52-1022	TF52-1012	TF52-1022
Cuspid	3 3	0°	0°	0.7	3	TF51-1113	TF51-1123	TF51-1013	TF51-1023	TF52-1113	TF52-1123	TF52-1013	TF52-1023
Bicuspid	4.5 4.5	0°	0°	0.7	2.7	TF51-1114	TF51-1124	TF51-1014	TF51-1024	TF52-1114	TF52-1124	TF52-1014	TF52-1024
MANDIBULAR ▼	Torque	Angle	In/out	Width	0.018 with hook		0.018 no hook		0.022 with hook		0.022 no hook		
					R	L	R	L	R	L	R	L	
Lower Anterior	1.2 1.2	0°	0°	0.7	2.3	TF51-1041	TF51-1031	TF51-1041	TF51-1031	TF52-1041	TF52-1031	TF52-1041	TF52-1031
Cuspid	3 3	0°	0°	0.7	2.3	TF51-1143	TF51-1133	TF51-1043	TF51-1033	TF52-1143	TF52-1133	TF52-1043	TF52-1033
1st Bicuspid	4 4	0°	0°	0.7	3	TF51-1144	TF51-1134	TF51-1044	TF51-1034	TF52-1144	TF52-1134	TF52-1044	TF52-1034
2nd Bicuspid	5 5	0°	0°	0.7	2.7	TF51-1145	TF51-1135	TF51-1045	TF51-1035	TF52-1145	TF52-1135	TF52-1045	TF52-1035

Full Kits ▲▼

20pcs/kit

Kits	package	no hook	3with hook	345with hook
.018	with laser mark	TF51-11	TF51-12	TF51-13
	no laser mark	TF51-01	TF51-02	TF51-03
.022	with laser mark	TF52-11	TF52-12	TF52-13
	no laser mark	TF52-01	TF52-02	TF52-03

MIM Standard Roth Brackets



MAXILLARY ▲	Torque	Angle	In/out	Width	0.018 with hook		0.018 no hook		0.022 with hook		0.022 no hook		
					R	L	R	L	R	L	R	L	
Central	1 1	12°	5°	0.8	3.8	TZ41-1011	TZ41-1021	TZ41-1011	TZ41-1021	TZ42-1011	TZ42-1021	TZ42-1011	TZ42-1021
Lateral	2 2	8°	9°	1.18	3.1	TZ41-1012	TZ41-1022	TZ41-1012	TZ41-1022	TZ42-1012	TZ42-1022	TZ42-1012	TZ42-1022
Cuspid	3 3	-2°	11°	0.8	3.6	TZ41-1113	TZ41-1123	TZ41-1013	TZ41-1023	TZ42-1113	TZ42-1123	TZ42-1013	TZ42-1023
Bicuspid	4.5 4.5	-7°	0°	0.8	3.1	TZ41-1114	TZ41-1124	TZ41-1014	TZ41-1024	TZ42-1114	TZ42-1124	TZ42-1014	TZ42-1024
MANDIBULAR ▼	Torque	Angle	In/out	Width	0.018 with hook		0.018 no hook		0.022 with hook		0.022 no hook		
					R	L	R	L	R	L	R	L	
Lower Anterior	1.2 1.2	-1°	0°	1.18	2.3	TZ41-1041	TZ41-1031	TZ41-1041	TZ41-1031	TZ42-1041	TZ42-1031	TZ42-1041	TZ42-1031
Cuspid	3 3	-11°	5°	0.8	3.1	TZ41-1143	TZ41-1133	TZ41-1043	TZ41-1033	TZ42-1143	TZ42-1133	TZ42-1043	TZ42-1033
1st Bicuspid	4 4	-17°	0°	0.8	3.1	TZ41-1144	TZ41-1134	TZ41-1044	TZ41-1034	TZ42-1144	TZ42-1134	TZ42-1044	TZ42-1034
2nd Bicuspid	5 5	-22°	0°	0.8	3.1	TZ41-1145	TZ41-1135	TZ41-1045	TZ41-1035	TZ42-1145	TZ42-1135	TZ42-1045	TZ42-1035

Full Kits ▲▼

20pcs/kit

Kits	package	no hook	3with hook	345with hook
.018	with laser mark	TZ41-11	TZ41-12	TZ41-13
	no laser mark	TZ41-01	TZ41-02	TZ41-03
.022	with laser mark	TZ42-11	TZ42-12	TZ42-13
	no laser mark	TZ42-01	TZ42-02	TZ42-03

MIM Standard MBT Brackets



MAXILLARY ▲	Torque	Angle	In/out	Width	0.018 with hook		0.018 no hook		0.022 with hook		0.022 no hook		
					R	L	R	L	R	L	R	L	
Central	1 1	17°	4°	0.7	3.35	TM41-1011	TM41-1021	TM41-1011	TM41-1021	TM42-1011	TM42-1021	TM42-1011	TM42-1021
Lateral	2 2	10°	8°	1.08	2.87	TM41-1012	TM41-1022	TM41-1012	TM41-1022	TM42-1012	TM42-1022	TM42-1012	TM42-1022
Cuspid	3 3	0°	8°	0.7	3.12	TM41-1113	TM41-1123	TM41-1013	TM41-1023	TM42-1113	TM42-1123	TM42-1013	TM42-1023
Bicuspid	4.5 4.5	-7°	0°	0.7	3	TM41-1114	TM41-1124	TM41-1014	TM41-1024	TM42-1114	TM42-1124	TM42-1014	TM42-1024
MANDIBULAR ▼	Torque	Angle	In/out	Width	0.018 with hook		0.018 no hook		0.022 with hook		0.022 no hook		
					R	L	R	L	R	L	R	L	
Lower Anterior	1.2 1.2	-6°	0°	0.9	2.34	TM41-1041	TM41-1031	TM41-1041	TM41-1031	TM42-1041	TM42-1031	TM42-1041	TM42-1031
Cuspid	3 3	0°	3°	0.7	3.12	TM41-1143	TM41-1133	TM41-1043	TM41-1033	TM42-1143	TM42-1133	TM42-1043	TM42-1033
1st Bicuspid	4 4	-12°	2°	0.7	3	TM41-1144	TM41-1134	TM41-1044	TM41-1034	TM42-1144	TM42-1134	TM42-1044	TM42-1034
2nd Bicuspid	5 5	-17°	2°	0.7	3	TM41-1145	TM41-1135	TM41-1045	TM41-1035	TM42-1145	TM42-1135	TM42-1045	TM42-1035

Full Kits ▲▼

20pcs/kit

Kits	package	no hook	3with hook	345with hook
.018	with laser mark	TM41-11	TM41-12	TM41-13
	no laser mark	TM41-01	TM41-02	TM41-03
.022	with laser mark	TM42-11	TM42-12	TM42-13
	no laser mark	TM42-01	TM42-02	TM42-03

MIM Standard Edgewise Brackets



MAXILLARY ▲	Torque	Angle	In/out	Width	0.018 with hook		0.018 no hook		0.022 with hook		0.022 no hook		
					R	L	R	L	R	L	R	L	
Central	1 1	0°	0°	0.7	3	TF41-1011	TF41-1021	TF41-1011	TF41-1021	TF42-1011	TF42-1021	TF42-1011	TF42-1021
Lateral	2 2	0°	0°	0.7	2.7	TF41-1012	TF41-1022	TF41-1012	TF41-1022	TF42-1012	TF42-1022	TF42-1012	TF42-1022
Cuspid	3 3	0°	0°	0.7	3	TF41-1113	TF41-1123	TF41-1013	TF41-1023	TF42-1113	TF42-1123	TF42-1013	TF42-1023
Bicuspid	4.5 4.5	0°	0°	0.7	2.7	TF41-1114	TF41-1124	TF41-1014	TF41-1024	TF42-1114	TF42-1124	TF42-1014	TF42-1024
MANDIBULAR ▼	Torque	Angle	In/out	Width	0.018 with hook		0.018 no hook		0.022 with hook		0.022 no hook		
					R	L	R	L	R	L	R	L	
Lower Anterior	1.2 1.2	0°	0°	0.7	2.3	TF41-1041	TF41-1031	TF41-1041	TF41-1031	TF42-1041	TF42-1031	TF42-1041	TF42-1031
Cuspid	3 3	0°	0°	0.7	2.3	TF41-1143	TF41-1133	TF41-1043	TF41-1033	TF42-1143	TF42-1133	TF42-1043	TF42-1033
1st Bicuspid	4 4	0°	0°	0.7	3	TF41-1144	TF41-1134	TF41-1044	TF41-1034	TF42-1144	TF42-1134	TF42-1044	TF42-1034
2nd Bicuspid	5 5	0°	0°	0.7	2.7	TF41-1145	TF41-1135	TF41-1045	TF41-1035	TF42-1145	TF42-1135	TF42-1045	TF42-1035

Full Kits ▲▼

20pcs/kit

Kits	package	no hook	3with hook	345with hook
.018	with laser mark	TF41-11	TF41-12	TF41-13
	no laser mark	TF41-01	TF41-02	TF41-03
.022	with laser mark	TF42-11	TF42-12	TF42-13
	no laser mark	TF42-01	TF42-02	TF42-03

MIM Series Brackets >> MIM Monoblock Series

The overall size of the brackets is smaller than the general brackets, and the appearance is delicate and beautiful.

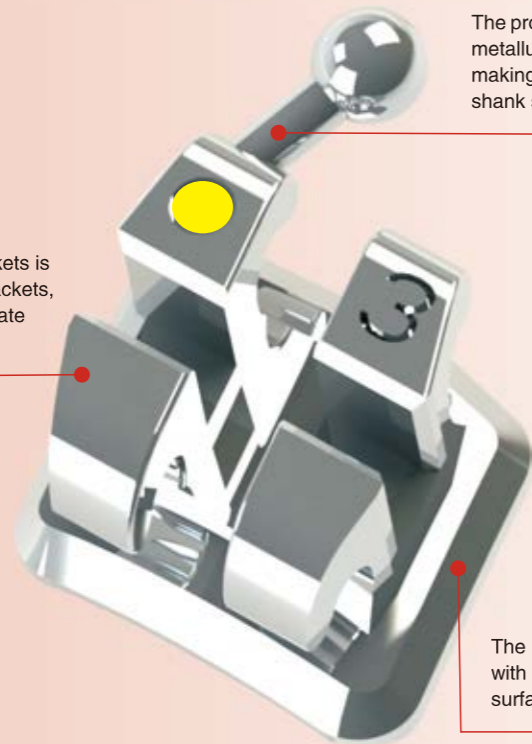

The product blank is produced by powder metallurgy process and injection molding, making the surface of the ball head and shank smooth and round.

The bottom of the monoblock brackets is designed with bumps to make the brackets and the tooth surface more fit and the bonding effect is better.

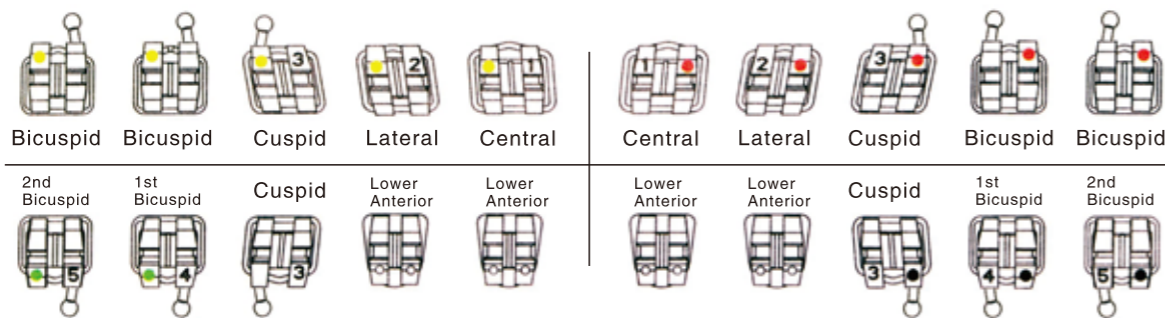

Monoblock Mini Roth Brackets 1G



MAXILLARY ▲	Torque	Angle	In/out	Width	0.018 with hook		0.018 no hook		0.022 with hook		0.022 no hook		
					R	L	R	L	R	L	R	L	
Central	1 1	12°	5°	0.8	3	TZ91-1011	TZ91-1021	TZ91-1011	TZ91-1021	TZ92-1011	TZ92-1021	TZ92-1011	TZ92-1021
Lateral	2 2	8°	9°	1.18	2.8	TZ91-1012	TZ91-1022	TZ91-1012	TZ91-1022	TZ92-1012	TZ92-1022	TZ92-1012	TZ92-1022
Cuspid	3 3	-2°	11°	0.8	3	TZ91-1113	TZ91-1123	TZ91-1013	TZ91-1023	TZ92-1113	TZ92-1123	TZ92-1013	TZ92-1023
Bicuspid	4,5 4,5	-7°	0°	0.8	2.8	TZ91-1114	TZ91-1124	TZ91-1014	TZ91-1024	TZ92-1114	TZ92-1124	TZ92-1014	TZ92-1024

MANDIBULAR ▼	Torque	Angle	In/out	Width	0.018 with hook		0.018 no hook		0.022 with hook		0.022 no hook		
					R	L	R	L	R	L	R	L	
Lower Anterior	1,2 1,2	-1°	0°	1.18	2.5	TZ91-1041	TZ91-1031	TZ91-1041	TZ91-1031	TZ92-1041	TZ92-1031	TZ92-1041	TZ92-1031
Cuspid	3 3	-11°	5°	0.8	2.8	TZ91-1143	TZ91-1133	TZ91-1043	TZ91-1033	TZ92-1143	TZ92-1133	TZ92-1043	TZ92-1033
1st Bicuspid	4 4	-17°	0°	0.8	2.8	TZ91-1144	TZ91-1134	TZ91-1044	TZ91-1034	TZ92-1144	TZ92-1134	TZ92-1044	TZ92-1034
2nd Bicuspid	5 5	-22°	0°	0.8	2.8	TZ91-1145	TZ91-1135	TZ91-1045	TZ91-1035	TZ92-1145	TZ92-1135	TZ92-1045	TZ92-1035

Full Kits ▲▼

20pcs/kit

Kits	package	no hook	3with hook	345with hook
.018	set	TZ91-11	TZ91-12	TZ91-13
.022	set	TZ92-11	TZ92-12	TZ92-13

Monoblock Mini Roth Brackets 3G



MAXILLARY ▲	Torque	Angle	In/out	Width	0.018 with hook		0.018 no hook		0.022 with hook		0.022 no hook		
					R	L	R	L	R	L	R	L	
Central	1 1	12°	5°	0.8	3	TZ01-1011	TZ01-1021	TZ01-1011	TZ01-1021	TZ02-1011	TZ02-1021	TZ02-1011	TZ02-1021
Lateral	2 2	8°	9°	1.18	2.8	TZ01-1012	TZ01-1022	TZ01-1012	TZ01-1022	TZ02-1012	TZ02-1022	TZ02-1012	TZ02-1022
Cuspid	3 3	-2°	11°	0.8	3	TZ01-1113	TZ01-1123	TZ01-1013	TZ01-1023	TZ02-1113	TZ02-1123	TZ02-1013	TZ02-1023
Bicuspid	4,5 4,5	-7°	0°	0.8	2.8	TZ01-1114	TZ01-1124	TZ01-1014	TZ01-1024	TZ02-1114	TZ02-1124	TZ02-1014	TZ02-1024

MANDIBULAR ▼	Torque	Angle	In/out	Width	0.018 with hook		0.018 no hook		0.022 with hook		0.022 no hook		
					R	L	R	L	R	L	R	L	
Lower Anterior	1,2 1,2	-1°	0°	1.18	2.5	TZ01-1041	TZ01-1031	TZ01-1041	TZ01-1031	TZ02-1041	TZ02-1031	TZ02-1041	TZ02-1031
Cuspid	3 3	-11°	5°	0.8	2.8	TZ01-1143	TZ01-1133	TZ01-1043	TZ01-1033	TZ02-1143	TZ02-1133	TZ02-1043	TZ02-1033
1st Bicuspid	4 4	-17°	0°	0.8	2.8	TZ01-1144	TZ01-1134	TZ01-1044	TZ01-1034	TZ02-1144	TZ02-1134	TZ02-1044	TZ02-1034
2nd Bicuspid	5 5	-22°	0°	0.8	2.8	TZ01-1145	TZ01-1135	TZ01-1045	TZ01-1035	TZ02-1145	TZ02-1135	TZ02-1045	TZ02-1035

Full Kits ▲▼

20pcs/kit

Kits	package	no hook	3with hook	345with hook
.018	set	TZ01-11	TZ01-12	TZ01-13
.022	set	TZ02-11	TZ02-12	TZ02-13

Monoblock Mini Roth Brackets 4G



MAXILLARY ▲	Torque	Angle	In/out	Width	0.018 with hook		0.018 no hook		0.022 with hook		0.022 no hook		
					R	L	R	L	R	L	R	L	
Central	1 1	12°	5°	0.8	3	TZ71-1011	TZ71-1021	TZ71-1011	TZ71-1021	TZ72-1011	TZ72-1021	TZ72-1011	TZ72-1021
Lateral	2 2	8°	9°	1.18	2.8	TZ71-1012	TZ71-1022	TZ71-1012	TZ71-1022	TZ72-1012	TZ72-1022	TZ72-1012	TZ72-1022
Cuspid	3 3	-2°	11°	0.8	3	TZ71-1113	TZ71-1123	TZ71-1013	TZ71-1023	TZ72-1113	TZ72-1123	TZ72-1013	TZ72-1023
Bicuspid	4,5 4,5	-7°	0°	0.8	2.8	TZ71-1114	TZ71-1124	TZ71-1014	TZ71-1024	TZ72-1114	TZ72-1124	TZ72-1014	TZ72-1024
MANDIBULAR ▼	Torque	Angle	In/out	Width	0.018 with hook		0.018 no hook		0.022 with hook		0.022 no hook		
					R	L	R	L	R	L	R	L	
Lower Anterior	1,2 1,2	-1°	0°	1.18	2.5	TZ71-1041	TZ71-1031	TZ71-1041	TZ71-1031	TZ72-1041	TZ72-1031	TZ72-1041	TZ72-1031
Cuspid	3 3	-11°	5°	0.8	2.8	TZ71-1143	TZ71-1133	TZ71-1043	TZ71-1033	TZ72-1143	TZ72-1133	TZ72-1043	TZ72-1033
1st Bicuspid	4 4	-17°	0°	0.8	2.8	TZ71-1144	TZ71-1134	TZ71-1044	TZ71-1034	TZ72-1144	TZ72-1134	TZ72-1044	TZ72-1034
2nd Bicuspid	5 5	-22°	0°	0.8	2.8	TZ71-1145	TZ71-1135	TZ71-1045	TZ71-1035	TZ72-1145	TZ72-1135	TZ72-1045	TZ72-1035

Full Kits ▲▼

20pcs/kit

Kits	package	no hook	3with hook	345with hook
.018	set	TZ71-11	TZ71-12	TZ71-13
.022	set	TZ72-11	TZ72-12	TZ72-13

Monoblock Mini MBT Brackets 1G



MAXILLARY ▲	Torque	Angle	In/out	Width	0.018 with hook		0.018 no hook		0.022 with hook		0.022 no hook		
					R	L	R	L	R	L	R	L	
Central	1 1	17°	4°	0.7	3	TM91-1011	TM91-1021	TM91-1011	TM91-1021	TM92-1011	TM92-1021	TM92-1011	TM92-1021
Lateral	2 2	10°	8°	1.08	2.8	TM91-1012	TM91-1022	TM91-1012	TM91-1022	TM92-1012	TM92-1022	TM92-1012	TM92-1022
Cuspid	3 3	0°	8°	0.7	2.9	TM91-1113	TM91-1123	TM91-1013	TM91-1023	TM92-1113	TM92-1123	TM92-1013	TM92-1023
Bicuspid	4,5 4,5	-7°	0°	0.7	2.9	TM91-1114	TM91-1124	TM91-1014	TM91-1024	TM92-1114	TM92-1124	TM92-1014	TM92-1024
MANDIBULAR ▼	Torque	Angle	In/out	Width	0.018 with hook		0.018 no hook		0.022 with hook		0.022 no hook		
					R	L	R	L	R	L	R	L	
Lower Anterior	1,2 1,2	-6°	0°	0.9	2.3	TM91-1041	TM91-1031	TM91-1041	TM91-1031	TM92-1041	TM92-1031	TM92-1041	TM92-1031
Cuspid	3 3	0°	3°	0.7	2.9	TM91-1143	TM91-1133	TM91-1043	TM91-1033	TM92-1143	TM92-1133	TM92-1043	TM92-1033
1st Bicuspid	4 4	-12°	2°	0.7	2.9	TM91-1144	TM91-1134	TM91-1044	TM91-1034	TM92-1144	TM92-1134	TM92-1044	TM92-1034
2nd Bicuspid	5 5	-17°	2°	0.7	2.9	TM91-1145	TM91-1135	TM91-1045	TM91-1035	TM92-1145	TM92-1135	TM92-1045	TM92-1035

Full Kits ▲▼

20pcs/kit

Kits	package	no hook	3with hook	345with hook
.018	set	TM91-11	TM91-12	TM91-13
.022	set	TM92-11	TM92-12	TM92-13

Monoblock Mini MBT Brackets 3G



MAXILLARY ▲	Torque	Angle	In/out	Width	0.018 with hook		0.018 no hook		0.022 with hook		0.022 no hook		
					R	L	R	L	R	L	R	L	
Central	1 1	17°	4°	0.7	3.1	TM01-1011	TM01-1021	TM01-1011	TM01-1021	TM02-1011	TM02-1021	TM02-1011	TM02-1021
Lateral	2 2	10°	8°	1.08	2.8	TM01-1012	TM01-1022	TM01-1012	TM01-1022	TM02-1012	TM02-1022	TM02-1012	TM02-1022
Cuspid	3 3	0°	8°	0.7	2.8	TM01-1113	TM01-1123	TM01-1013	TM01-1023	TM02-1113	TM02-1123	TM02-1013	TM02-1023
Bicuspid	4,5 4,5	-7°	0°	0.7	2.8	TM01-1114	TM01-1124	TM01-1014	TM01-1024	TM02-1114	TM02-1124	TM02-1014	TM02-1024
MANDIBULAR ▼	Torque	Angle	In/out	Width	0.018 with hook		0.018 no hook		0.022 with hook		0.022 no hook		
					R	L	R	L	R	L	R	L	
Lower Anterior	1,2 1,2	-6°	0°	0.9	2.2	TM01-1041	TM01-1031	TM01-1041	TM01-1031	TM02-1041	TM02-1031	TM02-1041	TM02-1031
Cuspid	3 3	0°	3°	0.7	2.8	TM01-1143	TM01-1133	TM01-1043	TM01-1033	TM02-1143	TM02-1133	TM02-1043	TM02-1033
1st Bicuspid	4 4	-12°	2°	0.7	2.8	TM01-1144	TM01-1134	TM01-1044	TM01-1034	TM02-1144	TM02-1134	TM02-1044	TM02-1034
2nd Bicuspid	5 5	-17°	2°	0.7	2.8	TM01-1145	TM01-1135	TM01-1045	TM01-1035	TM02-1145	TM02-1135	TM02-1045	TM02-1035

Full Kits ▲▼

20pcs/kit

Kits	package	no hook	3with hook	345with hook
.018	set	TM01-11	TM01-12	TM01-13
.022	set	TM02-11	TM02-12	TM02-13

Monoblock Mini Edgewise Brackets



MAXILLARY ▲	Torque	Angle	In/out	Width	0.018 with hook		0.018 no hook		0.022 with hook		0.022 no hook		
					R	L	R	L	R	L	R	L	
Central	1 1	0°	0°	0.6	2.9	TF91-1011	TF91-1021	TF91-1011	TF91-1021	TF92-1011	TF92-1021	TF92-1011	TF92-1021
Lateral	2 2	0°	0°	0.6	2.6	TF91-1012	TF91-1022	TF91-1012	TF91-1022	TF92-1012	TF92-1022	TF92-1012	TF92-1022
Cuspid	3 3	0°	0°	0.6	2.7	TF91-1113	TF91-1123	TF91-1013	TF91-1023	TF92-1113	TF92-1123	TF92-1013	TF92-1023
Bicuspid	4,5 4,5	0°	0°	0.6	2.7	TF91-1114	TF91-1124	TF91-1014	TF91-1024	TF92-1114	TF92-1124	TF92-1014	TF92-1024
MANDIBULAR ▼	Torque	Angle	In/out	Width	0.018 with hook		0.018 no hook		0.022 with hook		0.022 no hook		
					R	L	R	L	R	L	R	L	
Lower Anterior	1,2 1,2	0°	0°	0.6	2.3	TF91-1041	TF91-1031	TF91-1041	TF91-1031	TF92-1041	TF92-1031	TF92-1041	TF92-1031
Cuspid	3 3	0°	0°	0.6	2.7	TF91-1143	TF91-1133	TF91-1043	TF91-1033	TF92-1143	TF92-1133	TF92-1043	TF92-1033
1st Bicuspid	4 4	0°	0°	0.6	2.7	TF91-1144	TF91-1134	TF91-1044	TF91-1034	TF92-1144	TF92-1134	TF92-1044	TF92-1034
2nd Bicuspid	5 5	0°	0°	0.6	2.7	TF91-1145	TF91-1135	TF91-1045	TF91-1035	TF92-1145	TF92-1135	TF92-1045	TF92-1035

Full Kits ▲▼

20pcs/kit

Kits	package	no hook	3with hook	345with hook
.018	set	TF91-01	TF91-02	TF91-03
.022	set	TF92-01	TF92-02	TF92-03



Mini Roth Brackets

MAXILLARY ▲	Torque	Angle	In/out	Width	0.018 with hook		0.018 no hook		0.022 with hook		0.022 no hook		
					R	L	R	L	R	L	R	L	
Central	1 1	12°	5°	0.68	3.2	TZ21-1011	TZ21-1021	TZ21-1011	TZ21-1021	TZ22-1011	TZ22-1021	TZ22-1011	TZ22-1021
Lateral	2 2	8°	9°	1.06	2.8	TZ21-1012	TZ21-1022	TZ21-1012	TZ21-1022	TZ22-1012	TZ22-1022	TZ22-1012	TZ22-1022
Cuspid	3 3	-2°	11°	0.66	3.2	TZ21-1113	TZ21-1123	TZ21-1013	TZ21-1023	TZ22-1113	TZ22-1123	TZ22-1013	TZ22-1023
Bicuspid	4,5 4,5	-7°	0°	0.68	2.8	TZ21-1114	TZ21-1124	TZ21-1014	TZ21-1024	TZ22-1114	TZ22-1124	TZ22-1014	TZ22-1024

MANDIBULAR ▼	Torque	Angle	In/out	Width	0.018 with hook		0.018 no hook		0.022 with hook		0.022 no hook		
					R	L	R	L	R	L	R	L	
Lower Anterior	1,2 1,2	-1°	0°	1.06	2.5	TZ21-1041	TZ21-1031	TZ21-1041	TZ21-1031	TZ22-1041	TZ22-1031	TZ22-1041	TZ22-1031
Cuspid	3 3	-11°	5°	0.68	2.8	TZ21-1143	TZ21-1133	TZ21-1043	TZ21-1033	TZ22-1143	TZ22-1133	TZ22-1043	TZ22-1033
1st Bicuspid	4 4	-17°	0°	0.72	2.8	TZ21-1144	TZ21-1134	TZ21-1044	TZ21-1034	TZ22-1144	TZ22-1134	TZ22-1044	TZ22-1034
2nd Bicuspid	5 5	-22°	0°	0.68	2.8	TZ21-1145	TZ21-1135	TZ21-1045	TZ21-1035	TZ22-1145	TZ22-1135	TZ22-1045	TZ22-1035

Full Kits ▲▼

20pcs/kit

Kits	package	no hook	3with hook	345with hook
.018	with laser mark	TZ21-11	TZ21-12	TZ21-13
	no laser mark	TZ21-01	TZ21-02	TZ21-03
.022	with laser mark	TZ22-11	TZ22-12	TZ22-13
	no laser mark	TZ22-01	TZ22-02	TZ22-03



Mini MBT Brackets

MAXILLARY ▲	Torque	Angle	In/out	Width	0.018 with hook		0.018 no hook		0.022 with hook		0.022 no hook		
					R	L	R	L	R	L	R	L	
Central	1 1	17°	4°	0.7	3.1	TM21-1011	TM21-1021	TM21-1011	TM21-1021	TM22-1011	TM22-1021	TM22-1011	TM22-1021
Lateral	2 2	10°	8°	1.08	2.8	TM21-1012	TM21-1022	TM21-1012	TM21-1022	TM22-1012	TM22-1022	TM22-1012	TM22-1022
Cuspid	3 3	0°	8°	0.7	2.8	TM21-1113	TM21-1123	TM21-1013	TM21-1023	TM22-1113	TM22-1123	TM22-1013	TM22-1023
Bicuspid	4,5 4,5	-7°	0°	0.7	2.8	TM21-1114	TM21-1124	TM21-1014	TM21-1024	TM22-1114	TM22-1124	TM22-1014	TM22-1024

MANDIBULAR ▼	Torque	Angle	In/out	Width	0.018 with hook		0.018 no hook		0.022 with hook		0.022 no hook		
					R	L	R	L	R	L	R	L	
Lower Anterior	1,2 1,2	-6°	0°	0.9	2.2	TM21-1041	TM21-1031	TM21-1041	TM21-1031	TM22-1041	TM22-1031	TM22-1041	TM22-1031
Cuspid	3 3	0°	3°	0.7	2.8	TM21-1143	TM21-1133	TM21-1043	TM21-1033	TM22-1143	TM22-1133	TM22-1043	TM22-1033
1st Bicuspid	4 4	-12°	2°	0.7	2.8	TM21-1144	TM21-1134	TM21-1044	TM21-1034	TM22-1144	TM22-1134	TM22-1044	TM22-1034
2nd Bicuspid	5 5	-17°	2°	0.7	2.8	TM21-1145	TM21-1135	TM21-1045	TM21-1035	TM22-1145	TM22-1135	TM22-1045	TM22-1035

Full Kits ▲▼

20pcs/kit

Kits	package	no hook	3with hook	345with hook
.018	with laser mark	TM21-11	TM21-12	TM21-13
	no laser mark	TM21-01	TM21-02	TM21-03
.022	with laser mark	TM22-11	TM22-12	TM22-13
	no laser mark	TM22-01	TM22-02	TM22-03

Advantages of CNC brackets:

1. Low Speed Wire Cut technology ensures smoother surface and lower friction.
2. CNC fine process makes the accuracy of slot more precise, within ± 0.02 mm.
3. The body and base are laser beam welded together so there would be no solder included; the weld strength is strong; avoid deformation of slot and lose of torque expression under normal welding technology.
4. The mesh base design enlarges adhere area of brackets and reduces the risk of adhesive failure; Vacuum diffusin welding makes sure no solder would be included; The mesh base is not made from MIM material which lower the overall height of bracket; CNC does not use sand blasting technology.
5. Rounded contours make patients feel much more comfortable when wearing our brackets.
6. The bigger gap between base and wings makes it convenient for dentists to use elastomers.
7. Long axis can help dentist place our brackets more accurate.

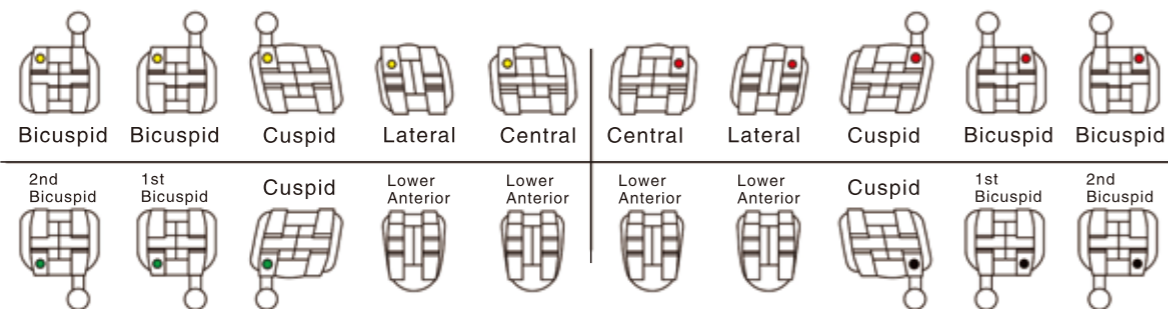

Mini Edgewise Brackets



	MAXILLARY ▲	Torque	Angle	In/out	Width	0.018 with hook		0.018 no hook		0.022 with hook		0.022 no hook	
						R	L	R	L	R	L	R	L
Central	1 1	0°	0°	0.7	3	TF21-1011	TF21-1021	TF21-1011	TF21-1021	TF22-1011	TF22-1021	TF22-1011	TF22-1021
Lateral	2 2	0°	0°	0.7	2.7	TF21-1012	TF21-1022	TF21-1012	TF21-1022	TF22-1012	TF22-1022	TF22-1012	TF22-1022
Cuspid	3 3	0°	0°	0.7	3.3	TF21-1113	TF21-1123	TF21-1013	TF21-1023	TF22-1113	TF22-1123	TF22-1013	TF22-1023
Bicuspid	4.5 4.5	0°	0°	0.7	3.2	TF21-1114	TF21-1124	TF21-1014	TF21-1024	TF22-1114	TF22-1124	TF22-1014	TF22-1024
	MANDIBULAR ▼	Torque	Angle	In/out	Width	0.018 with hook		0.018 no hook		0.022 with hook		0.022 no hook	
						R	L	R	L	R	L	R	L
Lower Anterior	1.2 1.2	0°	0°	0.7	2.3	TF21-1041	TF21-1031	TF21-1041	TF21-1031	TF22-1041	TF22-1031	TF22-1041	TF22-1031
Cuspid	3 3	0°	0°	0.7	3.3	TF21-1143	TF21-1133	TF21-1043	TF21-1033	TF22-1143	TF22-1133	TF22-1043	TF22-1033
1st Bicuspid	4 4	0°	0°	0.7	3.2	TF21-1144	TF21-1134	TF21-1044	TF21-1034	TF22-1144	TF22-1134	TF22-1044	TF22-1034
2nd Bicuspid	5 5	0°	0°	0.7	3.2	TF21-1144	TF21-1134	TF21-1044	TF21-1034	TF22-1144	TF22-1134	TF22-1044	TF22-1034

Full Kits ▲▼

20pcs/kit

Kits	package	no hook	3with hook	345with hook
.018	with laser mark	TF21-11	TF21-12	TF21-13
	no laser mark	TF21-01	TF21-02	TF21-03
.022	with laser mark	TF22-11	TF22-12	TF22-13
	no laser mark	TF22-01	TF22-02	TF22-03

Mini V-slot Roth Brackets



	MAXILLARY ▲	Torque	Angle	In/out	Width	0.018 with hook		0.018 no hook		0.022 with hook		0.022 no hook	
						R	L	R	L	R	L	R	L
Central	1 1	12°	5°	1.03	3.2	TZ61-1011	TZ61-1021	TZ61-1011	TZ61-1021	TZ62-1011	TZ62-1021	TZ62-1011	TZ62-1021
Lateral	2 2	8°	9°	1.1	2.8	TZ61-1012	TZ61-1022	TZ61-1012	TZ61-1022	TZ62-1012	TZ62-1022	TZ62-1012	TZ62-1022
Cuspid	3 3	-2°	11°	1	3.2	TZ61-1113	TZ61-1123	TZ61-1013	TZ61-1023	TZ62-1113	TZ62-1123	TZ62-1013	TZ62-1023
Bicuspid	4.5 4.5	-7°	0°	1.03	2.8	TZ61-1114	TZ61-1124	TZ61-1014	TZ61-1024	TZ62-1114	TZ62-1124	TZ62-1014	TZ62-1024
	MANDIBULAR ▼	Torque	Angle	In/out	Width	0.018 with hook		0.018 no hook		0.022 with hook		0.022 no hook	
						R	L	R	L	R	L	R	L
Lower Anterior	1.2 1.2	-1°	0°	1.25	2.5	TZ61-1041	TZ61-1031	TZ61-1041	TZ61-1031	TZ62-1041	TZ62-1031	TZ62-1041	TZ62-1031
Cuspid	3 3	-11°	5°	1.1	2.8	TZ61-1143	TZ61-1133	TZ61-1043	TZ61-1033	TZ62-1143	TZ62-1133	TZ62-1043	TZ62-1033
1st Bicuspid	4 4	-17°	0°	1.03	2.8	TZ61-1144	TZ61-1134	TZ61-1044	TZ61-1034	TZ62-1144	TZ62-1134	TZ62-1044	TZ62-1034
2nd Bicuspid	5 5	-22°	0°	1.03	2.8	TZ61-1145	TZ61-1135	TZ61-1045	TZ61-1035	TZ62-1145	TZ62-1135	TZ62-1045	TZ62-1035

Full Kits ▲▼

20pcs/kit

Kits	package	no hook	3with hook	345with hook
.018	with laser mark	TZ61-11	TZ61-12	TZ61-13
	no laser mark	TZ61-01	TZ61-02	TZ61-03
.022	with laser mark	TZ62-11	TZ62-12	TZ62-13
	no laser mark	TZ62-01	TZ62-02	TZ62-03

Mini V-slot MBT Brackets



	MAXILLARY ▲	Torque	Angle	In/out	Width	0.018 with hook		0.018 no hook		0.022 with hook		0.022 no hook	
						R	L	R	L	R	L	R	L
Central	1 1	17°	4°	1.03	3.2	TM61-1011	TM61-1021	TM61-1011	TM61-1021	TM62-1011	TM62-1021	TM62-1011	TM62-1021
Lateral	2 2	10°	8°	1.1	2.8	TM61-1012	TM61-1022	TM61-1012	TM61-1022	TM62-1012	TM62-1022	TM62-1012	TM62-1022
Cuspid	3 3	0°	8°	1	2.8	TM61-1113	TM61-1123	TM61-1013	TM61-1023	TM62-1113	TM62-1123	TM62-1013	TM62-1023
Bicuspid	4.5 4.5	-7°	0°	1.03	2.8	TM61-1114	TM61-1124	TM61-1014	TM61-1024	TM62-1114	TM62-1124	TM62-1014	TM62-1024
	MANDIBULAR ▼	Torque	Angle	In/out	Width	0.018 with hook		0.018 no hook		0.022 with hook		0.022 no hook	
						R	L	R	L	R	L	R	L
Lower Anterior	1.2 1.2	-6°	0°	1.25	2.5	TM61-1041	TM61-1031	TM61-1041	TM61-1031	TM62-1041	TM62-1031	TM62-1041	TM62-1031
Cuspid	3 3	0°	3°	1.1	3	TM61-1143	TM61-1133	TM61-1043	TM61-1033	TM62-1143	TM62-1133	TM62-1043	TM62-1033
1st Bicuspid	4 4	-12°	2°	1.03	2.8	TM61-1144	TM61-1134	TM61-1044	TM61-1034	TM62-1144	TM62-1134	TM62-1044	TM62-1034
2nd Bicuspid	5 5	-17°	2°	1.03	2.8	TM61-1145	TM61-1135	TM61-1045	TM61-1035	TM62-1145	TM62-1135	TM62-1045	TM62-1035

Full Kits ▲▼

20pcs/kit

Kits	package	no hook	3with hook	345with hook
.018	with laser mark	TM61-11	TM61-12	TM61-13
	no laser mark	TM61-01	TM61-02	TM61-03
.022	with laser mark	TM62-11	TM62-12	TM62-13
	no laser mark	TM62-01	TM62-02	TM62-03

Mini Ricketts Brackets



	MAXILLARY ▲	Torque	Angle	In/out	Width	0.018 with hook		0.018 no hook		0.022 with hook		0.022 no hook	
						R	L	R	L	R	L	R	L
Central	1 1	22°	5°	0.9	3.2	TR21-1011	TR21-1021	TR21-1011	TR21-1021	TR22-1011	TR22-1021	TR22-1011	TR22-1021
Lateral	2 2	14°	8°	0.9	2.6	TR21-1012	TR21-1022	TR21-1012	TR21-1022	TR22-1012	TR22-1022	TR22-1012	TR22-1022
Cuspid	3 3	7°	5°	0.75	3	TR21-1113	TR21-1123	TR21-1013	TR21-1023	TR22-1113	TR22-1123	TR22-1013	TR22-1023
Bicuspid	4.5 4.5	0°	0°	0.9	2.8	TR21-1114	TR21-1124	TR21-1014	TR21-1024	TR22-1114	TR22-1124	TR22-1014	TR22-1024
	MANDIBULAR ▼	Torque	Angle	In/out	Width	0.018 with hook		0.018 no hook		0.022 with hook		0.022 no hook	
						R	L	R	L	R	L	R	L
Lower Anterior	1.2 1.2	-1°	0°	1.46	2.3	TR21-1041	TR21-1031	TR21-1041	TR21-1031	TR22-1041	TR22-1031	TR22-1041	TR22-1031
Cuspid	3 3	7°	5°	0.75	2.8	TR21-1143	TR21-1133	TR21-1043	TR21-1033	TR22-1143	TR22-1133	TR22-1043	TR22-1033
1st Bicuspid	4 4	0°	0°	0.9	2.8	TR21-1144	TR21-1134	TR21-1044	TR21-1034	TR22-1144	TR22-1134	TR22-1044	TR22-1034
2nd Bicuspid	5 5	-11°	0°	0.9	2.8	TR21-1145	TR21-1135	TR21-1045	TR21-1035	TR22-1145	TR22-1135	TR22-1045	TR22-1035

Full Kits ▲▼

20pcs/kit

Kits	package	no hook	3with hook	345with hook
.018	with laser mark	TR21-11	TR21-12	TR21-13
	no laser mark	TR21-01	TR21-02	TR21-03
.022	with laser mark	TR22-11	TR22-12	TR22-13
	no laser mark	TR22-01	TR22-02	TR22-03

Standard Roth Brackets



MAXILLARY ▲	Torque	Angle	In/out	Width	0.018 with hook		0.018 no hook		0.022 with hook		0.022 no hook		
					R	L	R	L	R	L	R	L	
Central	1 1	12°	5°	0.8	3.6	TZ11-1011	TZ11-1021	TZ11-1011	TZ11-1021	TZ12-1011	TZ12-1021	TZ12-1011	TZ12-1021
Lateral	2 2	8°	9°	1.18	2.9	TZ11-1012	TZ11-1022	TZ11-1012	TZ11-1022	TZ12-1012	TZ12-1022	TZ12-1012	TZ12-1022
Cuspid	3 3	-2°	11°	0.8	3.3	TZ11-1113	TZ11-1123	TZ11-1013	TZ11-1023	TZ12-1113	TZ12-1123	TZ12-1013	TZ12-1023
Bicuspid	4,5 4,5	-7°	0°	0.8	3.2	TZ11-1114	TZ11-1124	TZ11-1014	TZ11-1024	TZ12-1114	TZ12-1124	TZ12-1014	TZ12-1024

MANDIBULAR ▼	Torque	Angle	In/out	Width	0.018 with hook		0.018 no hook		0.022 with hook		0.022 no hook		
					R	L	R	L	R	L	R	L	
Lower Anterior	1,2 1,2	-1°	0°	1.18	2.5	TZ11-1041	TZ11-1031	TZ11-1041	TZ11-1031	TZ12-1041	TZ12-1031	TZ12-1041	TZ12-1031
Cuspid	3 3	-11°	5°	0.8	3.2	TZ11-1143	TZ11-1133	TZ11-1043	TZ11-1033	TZ12-1143	TZ12-1133	TZ12-1043	TZ12-1033
1st Bicuspid	4 4	-17°	0°	0.8	3.2	TZ11-1144	TZ11-1134	TZ11-1044	TZ11-1034	TZ12-1144	TZ12-1134	TZ12-1044	TZ12-1034
2nd Bicuspid	5 5	-22°	0°	0.8	3.2	TZ11-1145	TZ11-1135	TZ11-1045	TZ11-1035	TZ12-1145	TZ12-1135	TZ12-1045	TZ12-1035

Full Kits ▲▼

20pcs/kit

Kits	package	no hook	3with hook	345with hook
.018	with laser mark	TZ11-11	TZ11-12	TZ11-13
	no laser mark	TZ11-01	TZ11-02	TZ11-03
.022	with laser mark	TZ12-11	TZ12-12	TZ12-13
	no laser mark	TZ12-01	TZ12-02	TZ12-03

Standard MBT Brackets



MAXILLARY ▲	Torque	Angle	In/out	Width	0.018 with hook		0.018 no hook		0.022 with hook		0.022 no hook		
					R	L	R	L	R	L	R	L	
Central	1 1	17°	4°	0.7	3.6	TM11-1011	TM11-1021	TM11-1011	TM11-1021	TM12-1011	TM12-1021	TM12-1011	TM12-1021
Lateral	2 2	10°	8°	1.1	2.9	TM11-1012	TM11-1022	TM11-1012	TM11-1022	TM12-1012	TM12-1022	TM12-1012	TM12-1022
Cuspid	3 3	0°	8°	0.7	3.3	TM11-1113	TM11-1123	TM11-1013	TM11-1023	TM12-1113	TM12-1123	TM12-1013	TM12-1023
Bicuspid	4 4	-7°	0°	0.7	3.2	TM11-1114	TM11-1124	TM11-1014	TM11-1024	TM12-1114	TM12-1124	TM12-1014	TM12-1024
Bicuspid	5 5	-7°	0°	0.9	3.2	TM11-1115	TM11-1125	TM11-1015	TM11-1025	TM12-1115	TM12-1125	TM12-1015	TM12-1025

MANDIBULAR ▼	Torque	Angle	In/out	Width	0.018 with hook		0.018 no hook		0.022 with hook		0.022 no hook		
					R	L	R	L	R	L	R	L	
Lower Anterior	1,2 1,2	-6°	0°	1.1	2.7	TM11-1041	TM11-1031	TM11-1041	TM11-1031	TM12-1041	TM12-1031	TM12-1041	TM12-1031
Cuspid	3 3	0°	3°	0.7	3.2	TM11-1143	TM11-1133	TM11-1043	TM11-1033	TM12-1143	TM12-1133	TM12-1043	TM12-1033
1st Bicuspid	4 4	-12°	2°	0.7	3.2	TM11-1144	TM11-1134	TM11-1044	TM11-1034	TM12-1144	TM12-1134	TM12-1044	TM12-1034
2nd Bicuspid	5 5	-17°	2°	0.7	3.2	TM11-1145	TM11-1135	TM11-1045	TM11-1035	TM12-1145	TM12-1135	TM12-1045	TM12-1035

Full Kits ▲▼

20pcs/kit

Kits	package	no hook	3with hook	345with hook
.018	with laser mark	TM11-11	TM11-12	TM11-13
	no laser mark	TM11-01	TM11-02	TM11-03
.022	with laser mark	TM12-11	TM12-12	TM12-13
	no laser mark	TM12-01	TM12-02	TM12-03

Standard Edgewise Brackets



MAXILLARY ▲	Torque	Angle	In/out	Width	0.018 with hook		0.018 no hook		0.022 with hook		0.022 no hook		
					R	L	R	L	R	L	R	L	
Central	1 1	0°	0°	0.7	3.3	TF11-1011	TF11-1021	TF11-1011	TF11-1021	TF12-1011	TF12-1021	TF12-1011	TF12-1021
Lateral	2 2	0°	0°	0.7	3	TF11-1012	TF11-1022	TF11-1012	TF11-1022	TF12-1012	TF12-1022	TF12-1012	TF12-1022
Cuspid	3 3	0°	0°	0.7	3.6	TF11-1113	TF11-1123	TF11-1013	TF11-1023	TF12-1113	TF12-1123	TF12-1013	TF12-1023
Bicuspid	4,5 4,5	0°	0°	0.7	3.3	TF11-1114	TF11-1124	TF11-1014	TF11-1024	TF12-1114	TF12-1124	TF12-1014	TF12-1024

MANDIBULAR ▼	Torque	Angle	In/out	Width	0.018 with hook		0.018 no hook		0.022 with hook		0.022 no hook		
					R	L	R	L	R	L	R	L	
Lower Anterior	1,2 1,2	0°	0°	0.7	2.5	TF11-1041	TF11-1031	TF11-1041	TF11-1031	TF12-1041	TF12-1031	TF12-1041	TF12-1031
Cuspid	3 3	0°	0°	0.7	3.6	TF11-1143	TF11-1133	TF11-1043	TF11-1033	TF12-1143	TF12-1133	TF12-1043	TF12-1033
1st Bicuspid	4 4	0°	0°	0.7	3.3	TF11-1144	TF11-1134	TF11-1044	TF11-1034	TF12-1144	TF12-1134	TF12-1044	TF12-1034
2nd Bicuspid	5 5	0°	0°	0.7	3.3	TF11-1144	TF11-1134	TF11-1044	TF11-1034	TF12-1144	TF12-1134	TF12-1044	TF12-1034

Full Kits ▲▼

20pcs/kit

Kits	package	no hook	3with hook	345with hook
.018	with laser mark	TF11-11	TF11-12	TF11-13
	no laser mark	TF11-01	TF11-02	TF11-03
.022	with laser mark	TF12-11	TF12-12	TF12-13
	no laser mark	TF12-01	TF12-02	TF12-03

Standard V-slot Roth Brackets



MAXILLARY ▲	Torque	Angle	In/out	Width	0.018 with hook		0.018 no hook		0.022 with hook		0.022 no hook		
					R	L	R	L	R	L	R	L	
Central	1 1	12°	5°	0.95	3.4	TZ31-1011	TZ31-1021	TZ31-1011	TZ31-1021	TZ32-1011	TZ32-1021	TZ32-1011	TZ32-1021
Lateral	2 2	8°	9°	1.43	2.8	TZ31-1012	TZ31-1022	TZ31-1012	TZ31-1022	TZ32-1012	TZ32-1022	TZ32-1012	TZ32-1022
Cuspid	3 3	-2°	11°	1.05	3	TZ31-1113	TZ31-1123	TZ31-1013	TZ31-1023	TZ32-1113	TZ32-1123	TZ32-1013	TZ32-1023
Bicuspid	4,5 4,5	-7°	0°	1.05	2.8	TZ31-1114	TZ31-1124	TZ31-1014	TZ31-1024	TZ32-1114	TZ32-1124	TZ32-1014	TZ32-1024

MANDIBULAR ▼	Torque	Angle	In/out	Width	0.018 with hook		0.018 no hook		0.022 with hook		0.022 no hook		
					R	L	R	L	R	L	R	L	
Lower Anterior	1,2 1,2	-1°	0°	1.43	2.5	TZ31-1041	TZ31-1031	TZ31-1041	TZ31-1031	TZ32-1041	TZ32-1031	TZ32-1041	TZ32-1031
Cuspid	3 3	-11°	5°	1.05	2.8	TZ31-1143	TZ31-1133	TZ31-1043	TZ31-1033	TZ32-1143	TZ32-1133	TZ32-1043	TZ32-1033
1st Bicuspid	4 4	-17°	0°	1.08	2.8	TZ31-1144	TZ31-1134	TZ31-1044	TZ31-1034	TZ32-1144	TZ32-1134	TZ32-1044	TZ32-1034
2nd Bicuspid	5 5	-22°	0°	1.11	2.8	TZ31-1145	TZ31-1135	TZ31-1045	TZ31-1035	TZ32-1145	TZ32-1135	TZ32-1045	TZ32-1035

Full Kits ▲▼

20pcs/kit

Kits	package	no hook	3with hook	345with hook
.018	with laser mark	TZ31-11	TZ31-12	TZ31-13
	no laser mark	TZ31-01	TZ31-02	TZ31-03
.022	with laser mark	TZ32-11	TZ32-12	TZ32-13
	no laser mark	TZ32-01	TZ32-02	TZ32-03

Standard V-slot MBT Brackets



MAXILLARY ▲	Torque	Angle	In/out	Width	0.018 with hook		0.018 no hook		0.022 with hook		0.022 no hook		
					R	L	R	L	R	L	R	L	
Central	1 1	17°	4°	0.95	3.4	TM31-1011	TM31-1021	TM31-1011	TM31-1021	TM32-1011	TM32-1021	TM32-1011	TM32-1021
Lateral	2 2	10°	8°	1.43	2.8	TM31-1012	TM31-1022	TM31-1012	TM31-1022	TM32-1012	TM32-1022	TM32-1012	TM32-1022
Cuspid	3 3	0°	8°	1.05	3	TM31-1113	TM31-1123	TM31-1013	TM31-1023	TM32-1113	TM32-1123	TM32-1013	TM32-1023
Bicuspid	4.5 4.5	-7°	0°	1.05	2.8	TM31-1114	TM31-1124	TM31-1014	TM31-1024	TM32-1114	TM32-1124	TM32-1014	TM32-1024
MANDIBULAR ▼	Torque	Angle	In/out	Width	0.018 with hook		0.018 no hook		0.022 with hook		0.022 no hook		
					R	L	R	L	R	L	R	L	
Lower Anterior	1.2 1.2	-6°	0°	1.43	2.5	TM31-1041	TM31-1031	TM31-1041	TM31-1031	TM32-1041	TM32-1031	TM32-1041	TM32-1031
Cuspid	3 3	0°	3°	1.05	2.8	TM31-1143	TM31-1133	TM31-1043	TM31-1033	TM32-1143	TM32-1133	TM32-1043	TM32-1033
1st Bicuspid	4 4	-12°	2°	1.08	2.8	TM31-1144	TM31-1134	TM31-1044	TM31-1034	TM32-1144	TM32-1134	TM32-1044	TM32-1034
2nd Bicuspid	5 5	-17°	2°	1.11	2.8	TM31-1145	TM31-1135	TM31-1045	TM31-1035	TM32-1145	TM32-1135	TM32-1045	TM32-1035

Full Kits ▲▼

20pcs/kit

Kits	package	no hook	3with hook	345with hook
.018	with laser mark	TM31-11	TM31-12	TM31-13
	no laser mark	TM31-01	TM31-02	TM31-03
.022	with laser mark	TM32-11	TM32-12	TM32-13
	no laser mark	TM32-01	TM32-02	TM32-03

Standard Ricketts Brackets



MAXILLARY ▲	Torque	Angle	In/out	Width	0.018 with hook		0.018 no hook		0.022 with hook		0.022 no hook		
					R	L	R	L	R	L	R	L	
Central	1 1	22°	5°	0.95	3.6	TR11-1011	TR11-1021	TR11-1011	TR11-1021	TR12-1011	TR12-1021	TR12-1011	TR12-1021
Lateral	2 2	14°	8°	0.95	2.9	TR11-1012	TR11-1022	TR11-1012	TR11-1022	TR12-1012	TR12-1022	TR12-1012	TR12-1022
Cuspid	3 3	7°	5°	0.8	3.3	TR11-1113	TR11-1123	TR11-1013	TR11-1023	TR12-1113	TR12-1123	TR12-1013	TR12-1023
Bicuspid	4.5 4.5	0°	0°	0.95	3.15	TR11-1114	TR11-1124	TR11-1014	TR11-1024	TR12-1114	TR12-1124	TR12-1014	TR12-1024
MANDIBULAR ▼	Torque	Angle	In/out	Width	0.018 with hook		0.018 no hook		0.022 with hook		0.022 no hook		
					R	L	R	L	R	L	R	L	
Lower Anterior	1.2 1.2	-1°	0°	1.55	2.5	TR11-1041	TR11-1031	TR11-1041	TR11-1031	TR12-1041	TR12-1031	TR12-1041	TR12-1031
Cuspid	3 3	7°	5°	0.8	3.3	TR11-1143	TR11-1133	TR11-1043	TR11-1033	TR12-1143	TR12-1133	TR12-1043	TR12-1033
1st Bicuspid	4 4	0°	0°	0.95	3.15	TR11-1144	TR11-1134	TR11-1044	TR11-1034	TR12-1144	TR12-1134	TR12-1044	TR12-1034
2nd Bicuspid	5 5	-11°	0°	0.94	3.15	TR11-1145	TR11-1135	TR11-1045	TR11-1035	TR12-1145	TR12-1135	TR12-1045	TR12-1035

Full Kits ▲▼

20pcs/kit

Kits	package	no hook	3with hook	345with hook
.018	with laser mark	TR11-11	TR11-12	TR11-13
	no laser mark	TR11-01	TR11-02	TR11-03
.022	with laser mark	TR12-11	TR12-12	TR12-13
	no laser mark	TR12-01	TR12-02	TR12-03

Standard Gemini Roth Brackets



MAXILLARY ▲	Torque	Angle	In/out	Width	0.018 with hook		0.018 no hook		0.022 with hook		0.022 no hook		
					R	L	R	L	R	L	R	L	
Central	1 1	12°	5°	0.8	3.55	TG11-1011	TG11-1021	TG11-1011	TG11-1021	TG12-1011	TG12-1021	TG12-1011	TG12-1021
Lateral	2 2	8°	9°	0.8	2.85	TG11-1012	TG11-1022	TG11-1012	TG11-1022	TG12-1012	TG12-1022	TG12-1012	TG12-1022
Cuspid	3 3	-2°	11°	0.8	3.35	TG11-1113	TG11-1123	TG11-1013	TG11-1023	TG12-1113	TG12-1123	TG12-1013	TG12-1023
Bicuspid	4.5 4.5	-7°	0°	0.8	3.2	TG11-1114	TG11-1124	TG11-1014	TG11-1024	TG12-1114	TG12-1124	TG12-1014	TG12-1024
MANDIBULAR ▼	Torque	Angle	In/out	Width	0.018 with hook		0.018 no hook		0.022 with hook		0.022 no hook		
					R	L	R	L	R	L	R	L	
Lower Anterior	1.2 1.2	-1°	0°	1.2	2.6	TG11-1041	TG11-1031	TG11-1041	TG11-1031	TG12-1041	TG12-1031	TG12-1041	TG12-1031
Cuspid	3 3	-11°	5°	0.8	3.35	TG11-1143	TG11-1133	TG11-1043	TG11-1033	TG12-1143	TG12-1133	TG12-1043	TG12-1033
1st Bicuspid	4 4	-17°	0°	0.81	3.2	TG11-1144	TG11-1134	TG11-1044	TG11-1034	TG12-1144	TG12-1134	TG12-1044	TG12-1034
2nd Bicuspid	5 5	-22°	0°	0.83	3.2	TG11-1145	TG11-1135	TG11-1045	TG11-1035	TG12-1145	TG12-1135	TG12-1045	TG12-1035

Full Kits ▲▼

20pcs/kit

Kits	package	no hook	3with hook	345with hook
.018	with laser mark	TG11-11	TG11-12	TG11-13
	no laser mark	TG11-01	TG11-02	TG11-03
.022	with laser mark	TG12-11	TG12-12	TG12-13
	no laser mark	TG12-01	TG12-02	TG12-03

Standard Gemini MBT Brackets



MAXILLARY ▲	Torque	Angle	In/out	Width	0.018 with hook		0.018 no hook		0.022 with hook		0.022 no hook		
					R	L	R	L	R	L	R	L	
Central	1 1	17°	4°	0.81	3.55	TG31-1011	TG31-1021	TG31-1011	TG31-1021	TG32-1011	TG32-1021	TG32-1011	TG32-1021
Lateral	2 2	10°	8°	1.1	2.85	TG31-1012	TG31-1022	TG31-1012	TG31-1022	TG32-1012	TG32-1022	TG32-1012	TG32-1022
Cuspid	3 3	0°	8°	0.8	3.35	TG31-1113	TG31-1123	TG31-1013	TG31-1023	TG32-1113	TG32-1123	TG32-1013	TG32-1023
Bicuspid	4 4	-7°	0°	0.8	3.2	TG31-1114	TG31-1124	TG31-1014	TG31-1024	TG32-1114	TG32-1124	TG32-1014	TG32-1024
Bicuspid	5 5	-7°	0°	1.03	3.2	TG31-1114	TG31-1124	TG31-1014	TG31-1024	TG32-1114	TG32-1124	TG32-1014	TG32-1024
MANDIBULAR ▼	Torque	Angle	In/out	Width	0.018 with hook		0.018 no hook		0.022 with hook		0.022 no hook		
					R	L	R	L	R	L	R	L	
Lower Anterior	1.2 1.2	-6°	0°	1.2	2.6	TG31-1041	TG31-1031	TG31-1041	TG31-1031	TG32-1041	TG32-1031	TG32-1041	TG32-1031
Cuspid	3 3	0°	3°	0.8	3.35	TG31-1143	TG31-1133	TG31-1043	TG31-1033	TG32-1143	TG32-1133	TG32-1043	TG32-1033
1st Bicuspid	4 4	-12°	2°	0.79	3.2	TG31-1144	TG31-1134	TG31-1044	TG31-1034	TG32-1144	TG32-1134	TG32-1044	TG32-1034
2nd Bicuspid	5 5	-17°	2°	0.82	3.2	TG31-1145	TG31-1135	TG31-1045	TG31-1035	TG32-1145	TG32-1135	TG32-1045	TG32-1035

Full Kits ▲▼

20pcs/kit

Kits	package	no hook	3with hook	345with hook
.018	with laser mark	TG31-11	TG31-12	TG31-13
	no laser mark	TG31-01	TG31-02	TG31-03
.022	with laser mark	TG32-11	TG32-12	TG32-13
	no laser mark	TG32-01	TG32-02	TG32-03

Ceramic Series Brackets >> Ceramic Self-Ligating Brackets CP2



CP2



Advantages of Ceramic Self Ligating Brackets 7G:

1. High-quality ceramic construction delivers superior aesthetics without sacrificing the strength and performance of metal brackets.
2. Twin Wing design allows application of various treatment techniques using Elastic chain O-ring, etc.
3. The patented T-shaped design ensures stable traction, precise 3D control, and higher efficiency in complex orthodontic cases.
4. All Round slot design minimizes wire sliding friction.
5. Round and sturdy hook, comfortable and able to ensure the fixation of the elastic chain.

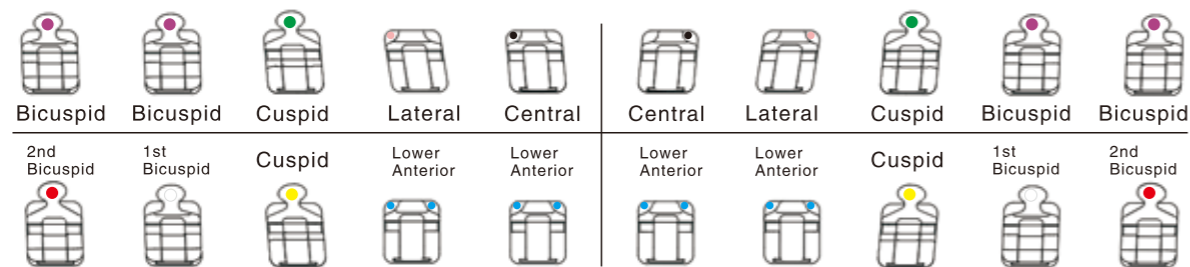

Self Ligating Roth Brackets CP2

MAXILLARY ▲	Torque	Angle	Width	0.018 with hook		0.018 no hook		0.022 with hook		0.022 no hook		
				R	L	R	L	R	L	R	L	
Central	1 1	12°	5°	3.8	SZ71-1011	SZ71-1021	SZ71-1011	SZ71-1021	SZ72-1011	SZ72-1021	SZ72-1011	SZ72-1021
Lateral	2 2	8°	9°	3.1	SZ71-1012	SZ71-1022	SZ71-1012	SZ71-1022	SZ72-1012	SZ72-1022	SZ72-1012	SZ72-1022
Cuspid	3 3	-2°	11°	3.6	SZ71-1113	SZ71-1123	SZ71-1013	SZ71-1023	SZ72-1113	SZ72-1123	SZ72-1013	SZ72-1023
Bicuspid	4,5 4,5	-7°	0°	3.1	SZ71-1114	SZ71-1124	SZ71-1014	SZ71-1024	SZ72-1114	SZ72-1124	SZ72-1014	SZ72-1024

MANDIBULAR ▼	Torque	Angle	Width	0.018 with hook		0.018 no hook		0.022 with hook		0.022 no hook		
				R	L	R	L	R	L	R	L	
Lower Anterior	1,2 1,2	-1°	0°	2.3	SZ71-1041	SZ71-1031	SZ71-1041	SZ71-1031	SZ72-1041	SZ72-1031	SZ72-1041	SZ72-1031
Cuspid	3 3	-11°	5°	3.1	SZ71-1143	SZ71-1133	SZ71-1043	SZ71-1033	SZ72-1143	SZ72-1133	SZ72-1043	SZ72-1033
1st Bicuspid	4 4	-17°	0°	3.1	SZ71-1144	SZ71-1134	SZ71-1044	SZ71-1034	SZ72-1144	SZ72-1134	SZ72-1044	SZ72-1034
2nd Bicuspid	5 5	-22°	0°	3.1	SZ71-1145	SZ71-1135	SZ71-1045	SZ71-1035	SZ72-1145	SZ72-1135	SZ72-1045	SZ72-1035

Full Kits ▲▼

20pcs/kit

Kits	package	no hook	3with hook	345with hook
.018	set	SZ71-01	SZ71-02	SZ71-03
.022	set	SZ72-01	SZ72-02	SZ72-03

Self Ligating MBT Brackets CP2



MAXILLARY ▲	Torque	Angle	Width	0.018 with hook		0.018 no hook		0.022 with hook		0.022 no hook		
				R	L	R	L	R	L	R	L	
Central	1 1	17°	4°	3.35	SM71-1011	SM71-1021	SM71-1011	SM71-1021	SM72-1011	SM72-1021	SM72-1011	SM72-1021
Lateral	2 2	10°	8°	2.87	SM71-1012	SM71-1022	SM71-1012	SM71-1022	SM72-1012	SM72-1022	SM72-1012	SM72-1022
Cuspid	3 3	0°	8°	3.12	SM71-1113	SM71-1123	SM71-1013	SM71-1023	SM72-1113	SM72-1123	SM72-1013	SM72-1023
Bicuspid	4,5 4,5	-7°	0°	3	SM71-1114	SM71-1124	SM71-1014	SM71-1024	SM72-1114	SM72-1124	SM72-1014	SM72-1024

MANDIBULAR ▼	Torque	Angle	Width	0.018 with hook		0.018 no hook		0.022 with hook		0.022 no hook		
				R	L	R	L	R	L	R	L	
Lower Anterior	1,2 1,2	-6°	0°	2.34	SM71-1041	SM71-1031	SM71-1041	SM71-1031	SM72-1041	SM72-1031	SM72-1041	SM72-1031
Cuspid	3 3	0°	3°	3.12	SM71-1143	SM71-1133	SM71-1043	SM71-1033	SM72-1143	SM72-1133	SM72-1043	SM72-1033
1st Bicuspid	4 4	-12°	2°	3	SM71-1144	SM71-1134	SM71-1044	SM71-1034	SM72-1144	SM72-1134	SM72-1044	SM72-1034
2nd Bicuspid	5 5	-17°	2°	3	SM71-1145	SM71-1135	SM71-1045	SM71-1035	SM72-1145	SM72-1135	SM72-1045	SM72-1035

Full Kits ▲▼

20pcs/kit

Kits	package	no hook	3with hook	345with hook
.018	set	SM71-01	SM71-02	SM71-03
.022	set	SM72-01	SM72-02	SM72-03

CA1



Advantages of Ceramic Self Ligating Brackets 2G:

1. The rounded and smooth shape improves the comfort of patients.
2. The shape is exquisite and clear, smooth and round, beautiful to clean, born for beauty.
3. Round and sturdy hook, comfortable and able to ensure the fixation of the elastic chain.

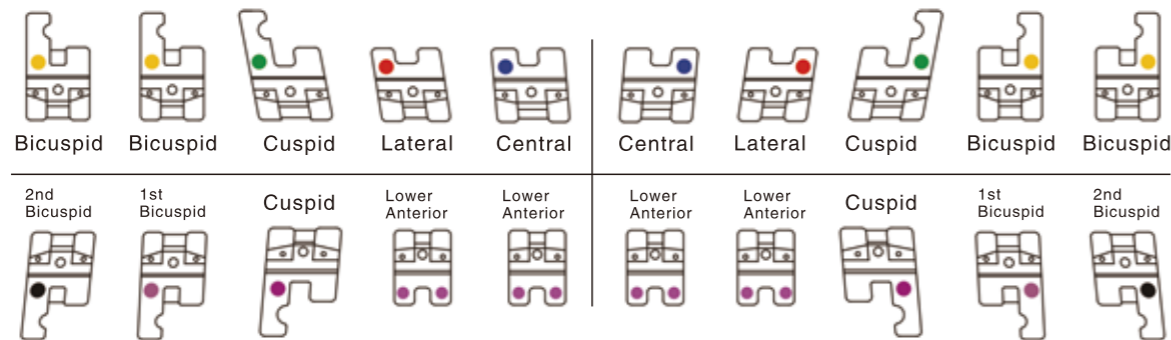

Self Ligating Roth Brackets CA1



MAXILLARY ▲	Torque	Angle	Width	0.018 with hook		0.018 no hook		0.022 with hook		0.022 no hook		
				R	L	R	L	R	L	R	L	
Central	1 1	11°	4°	3.3	SZ91-1011	SZ91-1021	SZ91-1011	SZ91-1021	SZ92-1011	SZ92-1021	SZ92-1011	SZ92-1021
Lateral	2 2	8°	9°	3	SZ91-1012	SZ91-1022	SZ91-1012	SZ91-1022	SZ92-1012	SZ92-1022	SZ92-1012	SZ92-1022
Cuspid	3 3	-2°	8°	3.4	SZ91-1113	SZ91-1123	SZ91-1013	SZ91-1023	SZ92-1113	SZ92-1123	SZ92-1013	SZ92-1023
Bicuspid	4,5 4,5	-7°	0°	3.3	SZ91-1114	SZ91-1124	SZ91-1014	SZ91-1024	SZ92-1114	SZ92-1124	SZ92-1014	SZ92-1024

MANDIBULAR ▼	Torque	Angle	Width	0.018 with hook		0.018 no hook		0.022 with hook		0.022 no hook		
				R	L	R	L	R	L	R	L	
Lower Anterior	1,2 1,2	0°	0°	2.9	SZ91-1041	SZ91-1031	SZ91-1041	SZ91-1031	SZ92-1041	SZ92-1031	SZ92-1041	SZ92-1031
Cuspid	3 3	-11°	7°	3.4	SZ91-1143	SZ91-1133	SZ91-1043	SZ91-1033	SZ92-1143	SZ92-1133	SZ92-1043	SZ92-1033
1st Bicuspid	4 4	-17°	3°	3.3	SZ91-1144	SZ91-1134	SZ91-1044	SZ91-1034	SZ92-1144	SZ92-1134	SZ92-1044	SZ92-1034
2nd Bicuspid	5 5	-21°	6°	3.3	SZ91-1145	SZ91-1135	SZ91-1045	SZ91-1035	SZ92-1145	SZ92-1135	SZ92-1045	SZ92-1035

Full Kits ▲▼

20pcs/kit

Kits	package	no hook	3with hook	345with hook
.018	set	SZ91-01	SZ91-02	SZ91-03
.022	set	SZ92-01	SZ92-02	SZ92-03

Self Ligating MBT Brackets CA1



MAXILLARY ▲	Torque	Angle	Width	0.018 with hook		0.018 no hook		0.022 with hook		0.022 no hook		
				R	L	R	L	R	L	R	L	
Central	1 1	17°	4°	3.35	SM91-1011	SM91-1021	SM91-1011	SM91-1021	SM92-1011	SM92-1021	SM92-1011	SM92-1021
Lateral	2 2	10°	8°	2.87	SM91-1012	SM91-1022	SM91-1012	SM91-1022	SM92-1012	SM92-1022	SM92-1012	SM92-1022
Cuspid	3 3	0°	8°	3.12	SM91-1113	SM91-1123	SM91-1013	SM91-1023	SM92-1113	SM92-1123	SM92-1013	SM92-1023
Bicuspid	4,5 4,5	-7°	0°	3	SM91-1114	SM91-1124	SM91-1014	SM91-1024	SM92-1114	SM92-1124	SM92-1014	SM92-1024

MANDIBULAR ▼	Torque	Angle	Width	0.018 with hook		0.018 no hook		0.022 with hook		0.022 no hook		
				R	L	R	L	R	L	R	L	
Lower Anterior	1,2 1,2	-6°	0°	2.34	SM91-1041	SM91-1031	SM91-1041	SM91-1031	SM92-1041	SM92-1031	SM92-1041	SM92-1031
Cuspid	3 3	0°	3°	3.12	SM91-1143	SM91-1133	SM91-1043	SM91-1033	SM92-1143	SM92-1133	SM92-1043	SM92-1033
1st Bicuspid	4 4	-12°	2°	3	SM91-1144	SM91-1134	SM91-1044	SM91-1034	SM92-1144	SM92-1134	SM92-1044	SM92-1034
2nd Bicuspid	5 5	-17°	2°	3	SM91-1145	SM91-1135	SM91-1045	SM91-1035	SM92-1145	SM92-1135	SM92-1045	SM92-1035

Full Kits ▲▼

20pcs/kit

Kits	package	no hook	3with hook	345with hook
.018	set	SM91-01	SM91-02	SM91-03
.022	set	SM92-01	SM92-02	SM92-03

Ceramic Series Brackets >> Ceramic Brackets



Advantages of Ceramic Brackets:

1. Advanced material: The MIX of advanced copolymers and ceramic material creates a translucent clearness for superior esthetics; and a hardness that doesn't flex, break, or stain.
2. Low friction: The combination of innovative technology and a unique fusion of material produces a "Glass-like appearance" for the lowest frictional resistance of any esthetic bracket, resulting in unmatched sliding mechanics, for the best tooth movement with minimal forces.

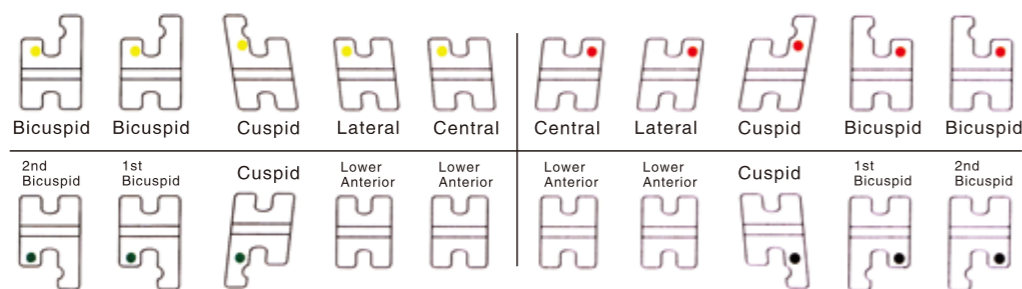

Ceramic Roth Brackets Three Groove

MAXILLARY ▲	Torque	Angle	In/out	Width	0.018 with hook		0.018 no hook		0.022 with hook		0.022 no hook		
					R	L	R	L	R	L	R	L	
Central	1 1	12°	5°	1.2	3.5	TZC1-1011	TZC1-1021	TZC1-1011	TZC1-1021	TZC2-1011	TZC2-1021	TZC2-1011	TZC2-1021
Lateral	2 2	8°	9°	1.5	3.3	TZC1-1012	TZC1-1022	TZC1-1012	TZC1-1022	TZC2-1012	TZC2-1022	TZC2-1012	TZC2-1022
Cuspid	3 3	-2°	11°	1.2	3.5	TZC1-1113	TZC1-1123	TZC1-1013	TZC1-1023	TZC2-1113	TZC2-1123	TZC2-1013	TZC2-1023
Bicuspid	4,5 4,5	-7°	0°	1.2	3.4	TZC1-1114	TZC1-1124	TZC1-1014	TZC1-1024	TZC2-1114	TZC2-1124	TZC2-1014	TZC2-1024

MANDIBULAR ▼	Torque	Angle	In/out	Width	0.018 with hook		0.018 no hook		0.022 with hook		0.022 no hook		
					R	L	R	L	R	L	R	L	
Lower Anterior	1,2 1,2	-1°	0°	1.5	3	TZC1-1041	TZC1-1031	TZC1-1041	TZC1-1031	TZC2-1041	TZC2-1031	TZC2-1041	TZC2-1031
Cuspid	3 3	-11°	5°	1.2	3.3	TZC1-1143	TZC1-1133	TZC1-1043	TZC1-1033	TZC2-1143	TZC2-1133	TZC2-1043	TZC2-1033
1st Bicuspid	4 4	-17°	0°	1.2	3.4	TZC1-1144	TZC1-1134	TZC1-1044	TZC1-1034	TZC2-1144	TZC2-1134	TZC2-1044	TZC2-1034
2nd Bicuspid	5 5	-22°	0°	1.2	3.4	TZC1-1145	TZC1-1135	TZC1-1045	TZC1-1035	TZC2-1145	TZC2-1135	TZC2-1045	TZC2-1035

Full Kits ▲▼

20pcs/kit

Kits	package	no hook	3with hook	345with hook
.018	set	TZC1-01	TZC1-02	TZC1-03
.022	set	TZC2-01	TZC2-02	TZC2-03

Ceramic MBT Brackets Three Groove

MAXILLARY ▲	Torque	Angle	In/out	Width	0.018 with hook		0.018 no hook		0.022 with hook		0.022 no hook		
					R	L	R	L	R	L	R	L	
Central	1 1	17°	4°	1.2	3.3	TMC1-1011	TMC1-1021	TMC1-1011	TMC1-1021	TMC2-1011	TMC2-1021	TMC2-1011	TMC2-1021
Lateral	2 2	10°	8°	1.5	3	TMC1-1012	TMC1-1022	TMC1-1012	TMC1-1022	TMC2-1012	TMC2-1022	TMC2-1012	TMC2-1022
Cuspid	3 3	0°	8°	1.2	3.6	TMC1-1113	TMC1-1123	TMC1-1013	TMC1-1023	TMC2-1113	TMC2-1123	TMC2-1013	TMC2-1023
Bicuspid	4,5 4,5	-7°	0°	1.2	3.3	TMC1-1114	TMC1-1124	TMC1-1014	TMC1-1024	TMC2-1114	TMC2-1124	TMC2-1014	TMC2-1024

MANDIBULAR ▼	Torque	Angle	In/out	Width	0.018 with hook		0.018 no hook		0.022 with hook		0.022 no hook		
					R	L	R	L	R	L	R	L	
Lower Anterior	1,2 1,2	-6°	0°	1.5	2.5	TMC1-1041	TMC1-1031	TMC1-1041	TMC1-1031	TMC2-1041	TMC2-1031	TMC2-1041	TMC2-1031
Cuspid	3 3	0°	3°	1.2	3.6	TMC1-1143	TMC1-1133	TMC1-1043	TMC1-1033	TMC2-1143	TMC2-1133	TMC2-1043	TMC2-1033
1st Bicuspid	4 4	-12°	2°	1.2	3.3	TMC1-1144	TMC1-1134	TMC1-1044	TMC1-1034	TMC2-1144	TMC2-1134	TMC2-1044	TMC2-1034
2nd Bicuspid	5 5	-17°	2°	1.2	3.3	TMC1-1145	TMC1-1135	TMC1-1045	TMC1-1035	TMC2-1145	TMC2-1135	TMC2-1045	TMC2-1035

Full Kits ▲▼

20pcs/kit

Kits	package	no hook	3with hook	345with hook
.018	set	TMC1-01	TMC1-02	TMC1-03
.022	set	TMC2-01	TMC2-02	TMC2-03

Ceramic Edgewise Brackets Three Groove



MAXILLARY ▲	Torque	Angle	In/out	Width	0.018 with hook		0.018 no hook		0.022 with hook		0.022 no hook		
					R	L	R	L	R	L	R	L	
Central	1 1	0°	0°	1.2	3	TFC1-1011	TFC1-1021	TFC1-1011	TFC1-1021	TFC2-1011	TFC2-1021	TFC2-1011	TFC2-1021
Lateral	2 2	0°	0°	1.2	3.4	TFC1-1012	TFC1-1022	TFC1-1012	TFC1-1022	TFC2-1012	TFC2-1022	TFC2-1012	TFC2-1022
Cuspid	3 3	0°	0°	1.2	3.4	TFC1-1113	TFC1-1123	TFC1-1013	TFC1-1023	TFC2-1113	TFC2-1123	TFC2-1013	TFC2-1023
Bicuspid	4.5 4.5	0°	0°	1.2	3.4	TFC1-1114	TFC1-1124	TFC1-1014	TFC1-1024	TFC2-1114	TFC2-1124	TFC2-1014	TFC2-1024

MANDIBULAR ▼	Torque	Angle	In/out	Width	0.018 with hook		0.018 no hook		0.022 with hook		0.022 no hook		
					R	L	R	L	R	L	R	L	
Lower Anterior	1.2 1.2	0°	0°	1.2	3	TFC1-1041	TFC1-1031	TFC1-1041	TFC1-1031	TFC2-1041	TFC2-1031	TFC2-1041	TFC2-1031
Cuspid	3 3	0°	0°	1.2	3.4	TFC1-1143	TFC1-1133	TFC1-1043	TFC1-1033	TFC2-1143	TFC2-1133	TFC2-1043	TFC2-1033
1st Bicuspid	4 4	0°	0°	1.2	3.4	TFC1-1144	TFC1-1134	TFC1-1044	TFC1-1034	TFC2-1144	TFC2-1134	TFC2-1044	TFC2-1034
2nd Bicuspid	5 5	0°	0°	1.2	3.4	TFC1-1144	TFC1-1134	TFC1-1044	TFC1-1034	TFC2-1144	TFC2-1134	TFC2-1044	TFC2-1034

Full Kits ▲▼

20pcs/kit

Kits	package	no hook	3with hook	345with hook
.018	set	TFC1-01	TFC1-02	TFC1-03
.022	set	TFC2-01	TFC2-02	TFC2-03

Ceramic Roth Brackets Gridding



MAXILLARY ▲	Torque	Angle	In/out	Width	0.018 with hook		0.018 no hook		0.022 with hook		0.022 no hook		
					R	L	R	L	R	L	R	L	
Central	1 1	12°	5°	1.2	3.5	TZC3-1011	TZC3-1021	TZC3-1011	TZC3-1021	TZC4-1011	TZC4-1021	TZC4-1011	TZC4-1021
Lateral	2 2	8°	9°	1.5	3.3	TZC3-1012	TZC3-1022	TZC3-1012	TZC3-1022	TZC4-1012	TZC4-1022	TZC4-1012	TZC4-1022
Cuspid	3 3	-2°	11°	1.2	3.5	TZC3-1113	TZC3-1123	TZC3-1013	TZC3-1023	TZC4-1113	TZC4-1123	TZC4-1013	TZC4-1023
Bicuspid	4.5 4.5	-7°	0°	1.2	3.4	TZC3-1114	TZC3-1124	TZC3-1014	TZC3-1024	TZC4-1114	TZC4-1124	TZC4-1014	TZC4-1024

MANDIBULAR ▼	Torque	Angle	In/out	Width	0.018 with hook		0.018 no hook		0.022 with hook		0.022 no hook		
					R	L	R	L	R	L	R	L	
Lower Anterior	1.2 1.2	-1°	0°	1.5	3	TZC3-1041	TZC3-1031	TZC3-1041	TZC3-1031	TZC4-1041	TZC4-1031	TZC4-1041	TZC4-1031
Cuspid	3 3	-11°	5°	1.2	3.3	TZC3-1143	TZC3-1133	TZC3-1043	TZC3-1033	TZC4-1143	TZC4-1133	TZC4-1043	TZC4-1033
1st Bicuspid	4 4	-17°	0°	1.2	3.4	TZC3-1144	TZC3-1134	TZC3-1044	TZC3-1034	TZC4-1144	TZC4-1134	TZC4-1044	TZC4-1034
2nd Bicuspid	5 5	-22°	0°	1.2	3.4	TZC3-1145	TZC3-1135	TZC3-1045	TZC3-1035	TZC4-1145	TZC4-1135	TZC4-1045	TZC4-1035

Full Kits ▲▼

20pcs/kit

Kits	package	no hook	3with hook	345with hook
.018	set	TZC3-01	TZC3-02	TZC3-03
.022	set	TZC4-01	TZC4-02	TZC4-03

Ceramic MBT Brackets Gridding



MAXILLARY ▲	Torque	Angle	In/out	Width	0.018 with hook		0.018 no hook		0.022 with hook		0.022 no hook		
					R	L	R	L	R	L	R	L	
Central	1 1	17°	4°	1.2	3.3	TMC3-1011	TMC3-1021	TMC3-1011	TMC3-1021	TMC4-1011	TMC4-1021	TMC4-1011	TMC4-1021
Lateral	2 2	10°	8°	1.5	3	TMC3-1012	TMC3-1022	TMC3-1012	TMC3-1022	TMC4-1012	TMC4-1022	TMC4-1012	TMC4-1022
Cuspid	3 3	0°	8°	1.2	3.6	TMC3-1113	TMC3-1123	TMC3-1013	TMC3-1023	TMC4-1113	TMC4-1123	TMC4-1013	TMC4-1023
Bicuspid	4.5 4.5	-7°	0°	1.2	3.3	TMC3-1114	TMC3-1124	TMC3-1014	TMC3-1024	TMC4-1114	TMC4-1124	TMC4-1014	TMC4-1024

MANDIBULAR ▼	Torque	Angle	In/out	Width	0.018 with hook		0.018 no hook		0.022 with hook		0.022 no hook		
					R	L	R	L	R	L	R	L	
Lower Anterior	1.2 1.2	-6°	0°	1.5	2.5	TMC3-1041	TMC3-1031	TMC3-1041	TMC3-1031	TMC4-1041	TMC4-1031	TMC4-1041	TMC4-1031
Cuspid	3 3	0°	3°	1.2	3.6	TMC3-1143	TMC3-1133	TMC3-1043	TMC3-1033	TMC4-1143	TMC4-1133	TMC4-1043	TMC4-1033
1st Bicuspid	4 4	-12°	2°	1.2	3.3	TMC3-1144	TMC3-1134	TMC3-1044	TMC3-1034	TMC4-1144	TMC4-1134	TMC4-1044	TMC4-1034
2nd Bicuspid	5 5	-17°	2°	1.2	3.3	TMC3-1145	TMC3-1135	TMC3-1045	TMC3-1035	TMC4-1145	TMC4-1135	TMC4-1045	TMC4-1035

Full Kits ▲▼

20pcs/kit

Kits	package	no hook	3with hook	345with hook
.018	set	TMC3-01	TMC3-02	TMC3-03
.022	set	TMC4-01	TMC4-02	TMC4-03

Ceramic Edgewise Brackets Gridding



MAXILLARY ▲	Torque	Angle	In/out	Width	0.018 with hook		0.018 no hook		0.022 with hook		0.022 no hook		
					R	L	R	L	R	L	R	L	
Central	1 1	0°	0°	1.2	3.6	TFC3-1011	TFC3-1021	TFC3-1011	TFC3-1021	TFC4-1011	TFC4-1021	TFC4-1011	TFC4-1021
Lateral	2 2	0°	0°	1.2	3.4	TFC3-1012	TFC3-1022	TFC3-1012	TFC3-1022	TFC4-1012	TFC4-1022	TFC4-1012	TFC4-1022
Cuspid	3 3	0°	0°	1.2	3.4	TFC3-1113	TFC3-1123	TFC3-1013	TFC3-1023	TFC4-1113	TFC4-1123	TFC4-1013	TFC4-1023
Bicuspid	4.5 4.5	0°	0°	1.2	3.4	TFC3-1114	TFC3-1124	TFC3-1014	TFC3-1024	TFC4-1114	TFC4-1124	TFC4-1014	TFC4-1024

MANDIBULAR ▼	Torque	Angle	In/out	Width	0.018 with hook		0.018 no hook		0.022 with hook		0.022 no hook		
					R	L	R	L	R	L	R	L	
Lower Anterior	1.2 1.2	0°	0°	1.2	3	TFC3-1041	TFC3-1031	TFC3-1041	TFC3-1031	TFC4-1041	TFC4-1031	TFC4-1041	TFC4-1031
Cuspid	3 3	0°	0°	1.2	3.4	TFC3-1143	TFC3-1133	TFC3-1043	TFC3-1033	TFC4-1143	TFC4-1133	TFC4-1043	TFC4-1033
1st Bicuspid	4 4	0°	0°	1.2	3.4	TFC3-1144	TFC3-1134	TFC3-1044	TFC3-1034	TFC4-1144	TFC4-1134	TFC4-1044	TFC4-1034
2nd Bicuspid	5 5	0°	0°	1.2	3.4	TFC3-1145	TFC3-1135	TFC3-1045	TFC3-1035	TFC4-1145	TFC4-1135	TFC4-1045	TFC4-1035

Full Kits ▲▼

20pcs/kit

Kits	package	no hook	3with hook	345with hook
.018	set	TFC3-01	TFC3-02	TFC3-03
.022	set	TFC4-01	TFC4-02	TFC4-03

Ceramic Roth Brackets 2G



MAXILLARY ▲	Torque	Angle	In/out	Width	0.018 with hook		0.018 no hook		0.022 with hook		0.022 no hook		
					R	L	R	L	R	L	R	L	
Central	1 1	12°	5°	1.2	3.5	TCR1-1011	TCR1-1021	TCR1-1011	TCR1-1021	TCR2-1011	TCR2-1021	TCR2-1011	TCR2-1021
Lateral	2 2	8°	9°	1.5	3.3	TCR1-1012	TCR1-1022	TCR1-1012	TCR1-1022	TCR2-1012	TCR2-1022	TCR2-1012	TCR2-1022
Cuspid	3 3	-2°	11°	1.2	3.5	TCR1-1113	TCR1-1123	TCR1-1013	TCR1-1023	TCR2-1113	TCR2-1123	TCR2-1013	TCR2-1023
Bicuspid	4,5 4,5	-7°	0°	1.2	3.4	TCR1-1114	TCR1-1124	TCR1-1014	TCR1-1024	TCR2-1114	TCR2-1124	TCR2-1014	TCR2-1024

MANDIBULAR ▼	Torque	Angle	In/out	Width	0.018 with hook		0.018 no hook		0.022 with hook		0.022 no hook		
					R	L	R	L	R	L	R	L	
Lower Anterior	1,2 1,2	-1°	0°	1.5	3	TCR1-1041	TCR1-1031	TCR1-1041	TCR1-1031	TCR2-1041	TCR2-1031	TCR2-1041	TCR2-1031
Cuspid	3 3	-11°	5°	1.2	3.3	TCR1-1143	TCR1-1133	TCR1-1043	TCR1-1033	TCR2-1143	TCR2-1133	TCR2-1043	TCR2-1033
1st Bicuspid	4 4	-17°	0°	1.2	3.4	TCR1-1144	TCR1-1134	TCR1-1044	TCR1-1034	TCR2-1144	TCR2-1134	TCR2-1044	TCR2-1034
2nd Bicuspid	5 5	-22°	0°	1.2	3.4	TCR1-1145	TCR1-1135	TCR1-1045	TCR1-1035	TCR2-1145	TCR2-1135	TCR2-1045	TCR2-1035

Full Kits ▲▼

20pcs/kit

Kits	package	no hook	3with hook	345with hook
.018	set	TCR1-01	TCR1-02	TCR1-03
.022	set	TCR2-01	TCR2-02	TCR2-03

Ceramic MBT Brackets 2G



MAXILLARY ▲	Torque	Angle	In/out	Width	0.018 with hook		0.018 no hook		0.022 with hook		0.022 no hook		
					R	L	R	L	R	L	R	L	
Central	1 1	17°	4°	1.2	3.3	TCM1-1011	TCM1-1021	TCM1-1011	TCM1-1021	TCM2-1011	TCM2-1021	TCM2-1011	TCM2-1021
Lateral	2 2	10°	8°	1.5	3	TCM1-1012	TCM1-1022	TCM1-1012	TCM1-1022	TCM2-1012	TCM2-1022	TCM2-1012	TCM2-1022
Cuspid	3 3	0°	8°	1.2	3.6	TCM1-1113	TCM1-1123	TCM1-1013	TCM1-1023	TCM2-1113	TCM2-1123	TCM2-1013	TCM2-1023
Bicuspid	4,5 4,5	-7°	0°	1.2	3.3	TCM1-1114	TCM1-1124	TCM1-1014	TCM1-1024	TCM2-1114	TCM2-1124	TCM2-1014	TCM2-1024

MANDIBULAR ▼	Torque	Angle	In/out	Width	0.018 with hook		0.018 no hook		0.022 with hook		0.022 no hook		
					R	L	R	L	R	L	R	L	
Lower Anterior	1,2 1,2	-6°	0°	1.5	2.5	TCM1-1041	TCM1-1031	TCM1-1041	TCM1-1031	TCM2-1041	TCM2-1031	TCM2-1041	TCM2-1031
Cuspid	3 3	0°	3°	1.2	3.6	TCM1-1143	TCM1-1133	TCM1-1043	TCM1-1033	TCM2-1143	TCM2-1133	TCM2-1043	TCM2-1033
1st Bicuspid	4 4	-12°	2°	1.2	3.3	TCM1-1144	TCM1-1134	TCM1-1044	TCM1-1034	TCM2-1144	TCM2-1134	TCM2-1044	TCM2-1034
2nd Bicuspid	5 5	-17°	2°	1.2	3.3	TCM1-1145	TCM1-1135	TCM1-1045	TCM1-1035	TCM2-1145	TCM2-1135	TCM2-1045	TCM2-1035

Full Kits ▲▼

20pcs/kit

Kits	package	no hook	3with hook	345with hook
.018	set	TCM1-01	TCM1-02	TCM1-03
.022	set	TCM2-01	TCM2-02	TCM2-03

Ceramic Roth Brackets 3G



MAXILLARY ▲	Torque	Angle	In/out	Width	0.022 with hook		
					R	L	
Central	1 1	12°	5°	1.2	3.5	TZC5-1011	TZC5-1021
Lateral	2 2	8°	9°	1.2	3.2	TZC5-1012	TZC5-1022
Cuspid	3 3	-2°	11°	1.2	3.5	TZC5-1113	TZC5-1123
Bicuspid	4,5 4,5	-7°	0°	1.2	3.5	TZC5-1114	TZC5-1024

MANDIBULAR ▼	Torque	Angle	In/out	Width	0.022 with hook		
					R	L	
Lower Anterior	1,2 1,2	-1°	0°	1.2	2.8	TZC5-1041	TZC5-1031
Cuspid	3 3	-11°	5°	1.2	3.5	TZC5-1143	TZC5-1133
1st Bicuspid	4 4	-17°	0°	1.2	3.5	TZC5-1144	TZC5-1134
2nd Bicuspid	5 5	-22°	0°	1.2	3.5	TZC5-1145	TZC5-1135

Full Kits ▲▼

20Ppcs/kit

Kits	package	with hook
.022	set	TZC5-03

Ceramic MBT Brackets 3G



MAXILLARY ▲	Torque	Angle	In/out	Width	0.022 with hook		
					R	L	
Central	1 1	17°	4°	1.2	3.5	TZC5-1011	TZC5-1021
Lateral	2 2	10°	8°	1.2	3.2	TZC5-1012	TZC5-1022
Cuspid	3 3	0°	8°	1.2	3.5	TZC5-1113	TZC5-1123
Bicuspid	4,5 4,5	-7°	0°	1.2	3.5	TZC5-1114	TZC5-1124

MANDIBULAR ▼	Torque	Angle	In/out	Width	0.022 with hook		
					R	L	
Lower Anterior	1,2 1,2	-6°	0°	1.2	2.8	TZC5-1041	TZC5-1031
Cuspid	3 3	0°	3°	1.2	3.5	TZC5-1143	TZC5-1133
1st Bicuspid	4 4	-12°	2°	1.2	3.5	TZC5-1144	TZC5-1134
2nd Bicuspid	5 5	-17°	2°	1.2	3.5	SZHY-1145	SZHY-1135

Full Kits ▲▼

20pcs/kit

Kits	package	with hook
.022	set	TZC5-03

Sapphire Series Brackets >> Sapphire Brackets



Advantages of Sapphire Brackets:



1. Using special plating and processing technology, easy to install and remove.
2. The rounded corners and ultra-thin design make installation more convenient.
3. Single crystal sapphire is super transparent, elegant and suitable for any tooth.

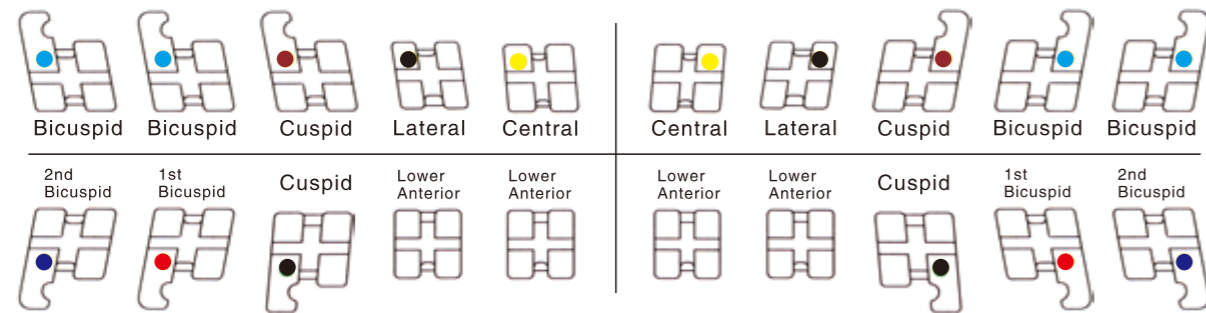

Sapphire Roth Brackets

MAXILLARY ▲	Torque	Angle	Width	0.018 with hook		0.018 no hook		0.022 with hook		0.022 no hook		
				R	L	R	L	R	L	R	L	
Central	1 1	12°	5°	3.2	TZS1-1011	TZS1-1021	TZS1-1011	TZS1-1021	TZS2-1011	TZS2-1021	TZS2-1011	TZS2-1021
Lateral	2 2	8°	9°	2.9	TZS1-1012	TZS1-1022	TZS1-1012	TZS1-1022	TZS2-1012	TZS2-1022	TZS2-1012	TZS2-1022
Cuspid	3 3	-2°	11°	3.4	TZS1-1113	TZS1-1123	TZS1-1013	TZS1-1023	TZS2-1113	TZS2-1123	TZS2-1013	TZS2-1023
Bicuspid	4,5 4,5	-7°	0°	3.2	TZS1-1114	TZS1-1124	TZS1-1014	TZS1-1024	TZS2-1114	TZS2-1124	TZS2-1014	TZS2-1024

MANDIBULAR ▼	Torque	Angle	Width	0.018 with hook		0.018 no hook		0.022 with hook		0.022 no hook		
				R	L	R	L	R	L	R	L	
Lower Anterior	1,2 1,2	-1°	0°	2.9	TZS1-1041	TZS1-1031	TZS1-1041	TZS1-1031	TZS2-1041	TZS2-1031	TZS2-1041	TZS2-1031
Cuspid	3 3	-11°	5°	3.4	TZS1-1143	TZS1-1133	TZS1-1043	TZS1-1033	TZS2-1143	TZS2-1133	TZS2-1043	TZS2-1033
1st Bicuspid	4 4	-17°	0°	3.2	TZS1-1144	TZS1-1134	TZS1-1044	TZS1-1034	TZS2-1144	TZS2-1134	TZS2-1044	TZS2-1034
2nd Bicuspid	5 5	-17°	0°	3.2	TZS1-1145	TZS1-1135	TZS1-1045	TZS1-1035	TZS2-1145	TZS2-1135	TZS2-1045	TZS2-1035

Full Kits ▲▼

20pcs/kit

Kits	package	no hook	3with hook	345with hook
.018	set	TZS1-01	TZS1-02	TZS1-03
.022	set	TZS2-01	TZS2-02	TZS2-03

Sapphire MBT Brackets

MAXILLARY ▲	Torque	Angle	Width	0.018 with hook		0.018 no hook		0.022 with hook		0.022 no hook		
				R	L	R	L	R	L	R	L	
Central	1 1	17°	4°	3.2	TMS1-1011	TMS1-1021	TMS1-1011	TMS1-1021	TMS2-1011	TMS2-1021	TMS2-1011	TMS2-1021
Lateral	2 2	10°	8°	2.9	TMS1-1012	TMS1-1022	TMS1-1012	TMS1-1022	TMS2-1012	TMS2-1022	TMS2-1012	TMS2-1022
Cuspid	3 3	0°	8°	3.4	TMS1-1113	TMS1-1123	TMS1-1013	TMS1-1023	TMS2-1113	TMS2-1123	TMS2-1013	TMS2-1023
Bicuspid	4,5 4,5	-7°	0°	3.2	TMS1-1114	TMS1-1124	TMS1-1014	TMS1-1024	TMS2-1114	TMS2-1124	TMS2-1014	TMS2-1024

MANDIBULAR ▼	Torque	Angle	Width	0.018 with hook		0.018 no hook		0.022 with hook		0.022 no hook		
				R	L	R	L	R	L	R	L	
Lower Anterior	1,2 1,2	-6°	0°	2.9	TMS1-1041	TMS1-1031	TMS1-1041	TMS1-1031	TMS2-1041	TMS2-1031	TMS2-1041	TMS2-1031
Cuspid	3 3	0°	3°	3.4	TMS1-1143	TMS1-1133	TMS1-1043	TMS1-1033	TMS2-1143	TMS2-1133	TMS2-1043	TMS2-1033
1st Bicuspid	4 4	-12°	0°	3.2	TMS1-1144	TMS1-1134	TMS1-1044	TMS1-1034	TMS2-1144	TMS2-1134	TMS2-1044	TMS2-1034
2nd Bicuspid	5 5	-12°	0°	3.2	TMS1-1145	TMS1-1135	TMS1-1045	TMS1-1035	TMS2-1145	TMS2-1135	TMS2-1045	TMS2-1035

Full Kits ▲▼

20pcs/kit

Kits	package	no hook	3with hook	345with hook
.018	set	TMS1-01	TMS1-02	TMS1-03
.022	set	TMS2-01	TMS2-02	TMS2-03

Sapphire Edgewise Brackets



MAXILLARY ▲	Torque	Angle	Width	0.018 with hook		0.018 no hook		0.022 with hook		0.022 no hook		
				R	L	R	L	R	L	R	L	
Central	1 1	0°	0°	3.3	TFS1-1011	TFS1-1021	TFS1-1011	TFS1-1021	TFS2-1011	TFS2-1021	TFS2-1011	TFS2-1021
Lateral	2 2	0°	0°	3	TFS1-1012	TFS1-1022	TFS1-1012	TFS1-1022	TFS2-1012	TFS2-1022	TFS2-1012	TFS2-1022
Cuspid	3 3	0°	0°	3.4	TFS1-1113	TFS1-1123	TFS1-1013	TFS1-1023	TFS2-1113	TFS2-1123	TFS2-1013	TFS2-1023
Bicuspid	4,5 4,5	0°	0°	3.3	TFS1-1114	TFS1-1124	TFS1-1014	TFS1-1024	TFS2-1114	TFS2-1124	TFS2-1014	TFS2-1024

MANDIBULAR ▼	Torque	Angle	Width	0.018 with hook		0.018 no hook		0.022 with hook		0.022 no hook		
				R	L	R	L	R	L	R	L	
Lower Anterior	1,2 1,2	0°	0°	2.9	TFS1-1041	TFS1-1031	TFS1-1041	TFS1-1031	TFS2-1041	TFS2-1031	TFS2-1041	TFS2-1031
Cuspid	3 3	0°	0°	3.4	TFS1-1143	TFS1-1133	TFS1-1043	TFS1-1033	TFS2-1143	TFS2-1133	TFS2-1043	TFS2-1033
1st Bicuspid	4 4	0°	0°	3.3	TFS1-1144	TFS1-1134	TFS1-1044	TFS1-1034	TFS2-1144	TFS2-1134	TFS2-1044	TFS2-1034
2nd Bicuspid	5 5	0°	0°	3.3	TFS1-1145	TFS1-1135	TFS1-1045	TFS1-1035	TFS2-1145	TFS2-1135	TFS2-1045	TFS2-1035

Full Kits ▲▼

20pcs/kit

Kits	package	no hook	3with hook	345with hook
.018	set	TFS1-01	TFS1-02	TFS1-03
.022	set	TFS2-01	TFS2-02	TFS2-03

Sapphire Series Brackets >> Sapphire Brackets With Indicator



Advantages of Sapphire Brackets with Indicator:

The design of the positioning indicator is added to facilitate precise positioning and accurate and convenient bonding.

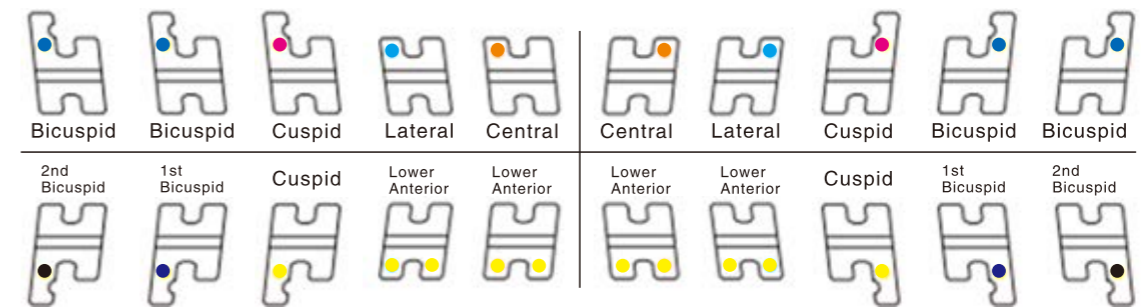

Sapphire Roth Brackets With Indicator



MAXILLARY ▲	Torque	Angle	Width	0.018 with hook		0.018 no hook		0.022 with hook		0.022 no hook		
				R	L	R	L	R	L	R	L	
Central	1 1	11°	4°	3.3	TZS3-1011	TZS3-1021	TZS3-1011	TZS3-1021	TZS4-1011	TZS4-1021	TZS4-1011	TZS4-1021
Lateral	2 2	8°	9°	3	TZS3-1012	TZS3-1022	TZS3-1012	TZS3-1022	TZS4-1012	TZS4-1022	TZS4-1012	TZS4-1022
Cuspid	3 3	-2°	8°	3.4	TZS3-1113	TZS3-1123	TZS3-1013	TZS3-1023	TZS4-1113	TZS4-1123	TZS4-1013	TZS4-1023
Bicuspid	4,5 4,5	-7°	0°	3.3	TZS3-1114	TZS3-1124	TZS3-1014	TZS3-1024	TZS4-1114	TZS4-1124	TZS4-1014	TZS4-1024

MANDIBULAR ▼	Torque	Angle	Width	0.018 with hook		0.018 no hook		0.022 with hook		0.022 no hook		
				R	L	R	L	R	L	R	L	
Lower Anterior	1,2 1,2	0°	0°	2.9	TZS3-1041	TZS3-1031	TZS3-1041	TZS3-1031	TZS4-1041	TZS4-1031	TZS4-1041	TZS4-1031
Cuspid	3 3	-11°	7°	3.4	TZS3-1143	TZS3-1133	TZS3-1043	TZS3-1033	TZS4-1143	TZS4-1133	TZS4-1043	TZS4-1033
1st Bicuspid	4 4	-17°	3°	3.3	TZS3-1144	TZS3-1134	TZS3-1044	TZS3-1034	TZS4-1144	TZS4-1134	TZS4-1044	TZS4-1034
2nd Bicuspid	5 5	-21°	6°	3.3	TZS3-1145	TZS3-1135	TZS3-1045	TZS3-1035	TZS4-1145	TZS4-1135	TZS4-1045	TZS4-1035

Full Kits ▲▼

20pcs/kit

Kits	package	no hook	3with hook	345with hook
.018	set	TZS3-01	TZS3-02	TZS3-03
.022	set	TZS4-01	TZS4-02	TZS4-03

Sapphire MBT Brackets With Indicator



MAXILLARY ▲	Torque	Angle	Width	0.018 with hook		0.018 no hook		0.022 with hook		0.022 no hook		
				R	L	R	L	R	L	R	L	
Central	1 1	18°	4°	3.3	TMS3-1011	TMS3-1021	TMS3-1011	TMS3-1021	TMS4-1011	TMS4-1021	TMS4-1011	TMS4-1021
Lateral	2 2	11°	8°	3	TMS3-1012	TMS3-1022	TMS3-1012	TMS3-1022	TMS4-1012	TMS4-1022	TMS4-1012	TMS4-1022
Cuspid	3 3	-8°	8°	3.4	TMS3-1113	TMS3-1123	TMS3-1013	TMS3-1023	TMS4-1113	TMS4-1123	TMS4-1013	TMS4-1023
Bicuspid	4,5 4,5	-8°	0°	3.3	TMS3-1114	TMS3-1124	TMS3-1014	TMS3-1024	TMS4-1114	TMS4-1124	TMS4-1014	TMS4-1024

MANDIBULAR ▼	Torque	Angle	Width	0.018 with hook		0.018 no hook		0.022 with hook		0.022 no hook		
				R	L	R	L	R	L	R	L	
Lower Anterior	1,2 1,2	-6°	0°	2.9	TMS3-1041	TMS3-1031	TMS3-1041	TMS3-1031	TMS4-1041	TMS4-1031	TMS4-1041	TMS4-1031
Cuspid	3 3	-6°	4°	3.4	TMS3-1143	TMS3-1133	TMS3-1043	TMS3-1033	TMS4-1143	TMS4-1133	TMS4-1043	TMS4-1033
1st Bicuspid	4 4	-13°	2°	3.3	TMS3-1144	TMS3-1134	TMS3-1044	TMS3-1034	TMS4-1144	TMS4-1134	TMS4-1044	TMS4-1034
2nd Bicuspid	5 5	-18°	2°	3.3	TMS3-1145	TMS3-1135	TMS3-1045	TMS3-1035	TMS4-1145	TMS4-1135	TMS4-1045	TMS4-1035

Full Kits ▲▼

20pcs/kit

Kits	package	no hook	3with hook	345with hook
.018	set	TMS3-01	TMS3-02	TMS3-03
.022	set	TMS4-01	TMS4-02	TMS4-03

Other Series Brackets >> VS Synchronous Brackets

Improve correction rate:
While correcting the shape and relationship of the upper and lower dental arches, the corrective force can be generated by elastic ligation and tightening of the bilateral wings of the bracket, effectively correct the vertical, lip tongue, axial inclination, and torque of teeth.

Convenient control of friction:
The movable wing bracket can adjust the width of each bracket groove according to the doctor's needs, so as to conveniently adjust the friction force between the support bracket and the arch wire.

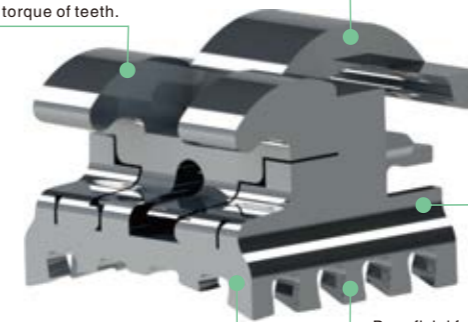

Mild discomfort:
The applied force on significantly misaligned teeth is also smaller, the size of the arch wire used in the movable wing correction technique is relatively small, combined with adjustable width grooves and adjustable elasticity. The buffering effect generated by ligation can achieve gentle force application. The effect is to alleviate the patient's discomfort.

Beneficial for stabilizing the occlusal plane:
Stabilize the occlusal plane and arch shape, making it less prone to tilting and rotation. And it can maintain the overall movement of the anchorage teeth, enhance the anchorage, and also reduce the emergence of new deformities in orthodontic treatment is missing.

Beneficial for correcting correction deviation:
The availability of grooves can reduce the impact of errors during the treatment process. When correction is needed, adjust the position of the bracket or bend the arch wire for that deviation. Elastic ligation after treatment can ensure that the teeth are in place without affects the overall correction process.

VS Synchronous Brackets



MAXILLARY ▲	Thickness	Groove depth	Groove wide	Groove length	Torque	Angle	Compensation	Item No.	
Central	1 1	1.4mm	0.72mm	0-2mm	3.2mm	8°	0°	0°	TH11-1011
Lateral	2 2	1.4mm	0.72mm	0-2mm	2.8mm	5°	0°	0°	TH11-1012
Cuspid	3 3	1.4mm	0.72mm	0-2mm	3.2mm	0°	0°	0°	TH11-1013
Bicuspid	4 4	1.4mm	0.72mm	0-2mm	3.2mm	0°	0°	0°	TH11-1014
Bicuspid	5 5	1.4mm	0.72mm	0-2mm	3.2mm	0°	0°	0°	TH11-1015

MANDIBULAR ▼	Thickness	Groove depth	Groove wide	Groove length	Torque	Angle	Compensation	Item No.	
Lower Anterior	1 1	1.4mm	0.72mm	0-2mm	2.6mm	0°	0°	0°	TH11-1031
Lower Anterior	2 2	1.4mm	0.72mm	0-2mm	2.6mm	0°	0°	0°	TH11-1032
Cuspid	3 3	1.4mm	0.72mm	0-2mm	3.2mm	0°	0°	0°	TH11-1033
1st Bicuspid	4 4	1.4mm	0.72mm	0-2mm	3.2mm	0°	0°	0°	TH11-1034
2nd Bicuspid	5 5	1.4mm	0.72mm	0-2mm	3.2mm	0°	0°	0°	TH11-1035

	Thickness	Groove depth	Groove wide	Groove length	Torque	Angle	Compensation	Item No.	
6th Buccal tubes	6 6	/	0.8mm	0.58mm	3mm	0°	0°	0°	TH11-1016
7th Buccal tubes	7 7	/	Φ0.86mm	Φ0.86mm	2.5mm	0°	0°	0°	TH11-1017

Full Kits ▲▼

28pcs/kit

Kits	Package	Item No.
28pcs/set	With laser mark	TH11-01
	No laser mark	TH11-02

Other Series Brackets >> Lingual Brackets

Lingual Brackets



MAXILLARY ▲							MANDIBULAR ▼						
Torque	Angle	In/out	Width	Item NO.		Torque	Angle	In/out	Width	Item NO.			
1 1	-32°	0°	0.9	2.5	TZL1-1011 TZL1-1021	1 1	-48°	0°	0.9	2.1	TZL1-1041 TZL1-1031		
2 2	-38°	0°	0.9	2	TZL1-1012 TZL1-1022	2 2	-48°	0°	0.9	2.1	TZL1-1041 TZL1-1031		
3 3	-42°	0°	0.7	2.4	TZL1-1113 TZL1-1123	3 3	-52°	0°	0.7	2.1	TZL1-1143 TZL1-1133		
4 4	10°	0°	0.7	2.5	TZL1-1114 TZL1-1124	4 4	-10°	0°	0.7	2.5	TZL1-1144 TZL1-1134		
5 5	10°	0°	0.7	2.5	TZL1-1114 TZL1-1124	5 5	-10°	0°	0.7	2.5	TZL1-1145 TZL1-1135		
6 6	10°	0°	0.7	3.8	TZL1-1116 TZL1-1126	6 6	-10°	0°	0.7	3.8	TZL1-1146 TZL1-1146		
7 7	10°	0°	0.7	3.8	TZL1-1117 TZL1-1127	7 7	-10°	0°	0.7	3.8	TZL1-1147 TZL1-1147		

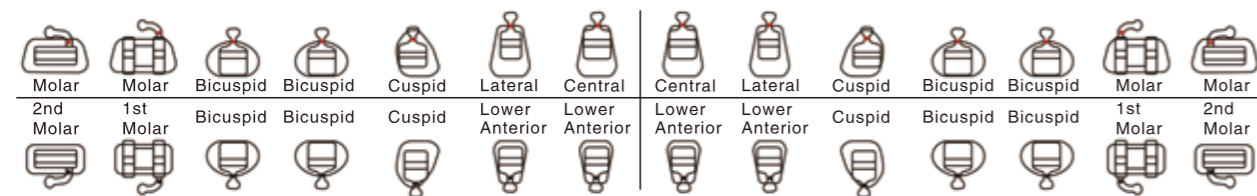

Full Kits ▲▼

28pcs/kit

Kits	package	Item No.
321 123 321 123	.018 set	TZL0-01
7654 4567 7654 4567	.022 set	28pcs/set

Other Series Brackets >> Alexander Brackets

Alexander Brackets



MAXILLARY ▲	Torque	Angle	In/out	Width	0.018 with hook		0.018 no hook		0.022 with hook		0.022 no hook		
					R	L	R	L	R	L	R	L	
Central	1 1	14°	5°	1	3.5	TZA1-1011	TZA1-1021	TZA1-1011	TZA1-1021	TZA2-1011	TZA2-1021	TZA2-1011	TZA2-1021
Lateral	2 2	7°	8°	1.2	3.1	TZA1-1012	TZA1-1022	TZA1-1012	TZA1-1022	TZA2-1012	TZA2-1022	TZA2-1012	TZA2-1022
Cuspid	3 3	-3°	10°	1	6.7	TZA1-1113	TZA1-1123	TZA1-1013	TFC1-1023	TZA2-1113	TZA2-1123	TZA2-1013	TZA2-1023
Bicuspid	4,5 4,5	-7°	0°	1	5	TZA1-1114	TZA1-1124	TZA1-1014	TZA1-1024	TZA2-1114	TZA2-1124	TZA2-1014	TZA2-1024

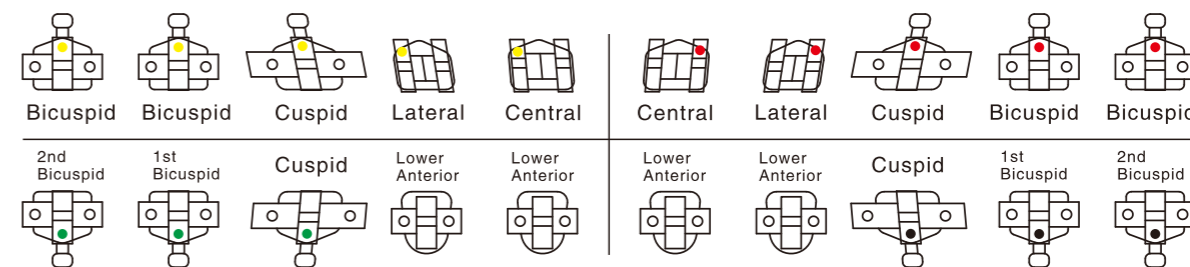

MANDIBULAR ▼	Torque	Angle	In/out	Width	0.018 with hook		0.018 no hook		0.022 with hook		0.022 no hook		
					R	L	R	L	R	L	R	L	
Lower Anterior	1,2 1,2	-5°	0°	1.3	4.5	TZA1-1041	TZA1-1031	TZA1-1041	TZA1-1031	TZA2-1041	TZA2-1031	TZA2-1041	TZA2-1031
Cuspid	3 3	-7°	6°	0.9	6.7	TZA1-1143	TZA1-1133	TZA1-1043	TZA1-1033	TZA2-1143	TZA2-1133	TZA2-1043	TZA2-1033
1st Bicuspid	4 4	-11°	0°	0.9	5	TZA1-1144	TZA1-1134	TZA1-1044	TZA1-1034	TZA2-1144	TZA2-1134	TZA2-1044	TZA2-1034
2nd Bicuspid	5 5	-17°	0°	0.9	5	TZA1-1145	TZA1-1135	TZA1-1045	TZA1-1035	TZA2-1145	TZA2-1135	TZA2-1045	TZA2-1035

Full Kits ▲▼

20pcs/kit

Kits	package	no hook	3with hook	345with hook
.018	with laser mark	TZA1-11	TZA1-12	TZA1-13
	no laser mark	TZA1-01	TZA1-02	TZA1-03
.022	with laser mark	TZA2-11	TZA2-12	TZA2-13
	no laser mark	TZA2-01	TZA2-02	TZA2-03

Light Force Roth Brackets (six-wing brackets)



MAXILLARY ▲	Torque	Angle	In/out	Width	0.022 with hook		0.022 no hook		
					R	L	R	L	
Central	<u>1 1</u>	12°	5°	0.8	3	TZQ2-1011	TZQ2-1021	TZQ2-1011	TZQ2-1021
Lateral	<u>2 2</u>	8°	9°	1.18	2.8	TZQ2-1012	TZQ2-1022	TZQ2-1012	TZQ2-1022
Cuspid	<u>3 3</u>	-2°	11°	0.8	3	TZQ2-1113	TZQ2-1123	TZQ2-1013	TZQ2-1023
Bicuspid	<u>4,5 4,5</u>	-7°	0°	0.8	2.8	TZQ2-1114	TZQ2-1124	TZQ2-1014	TZQ2-1024

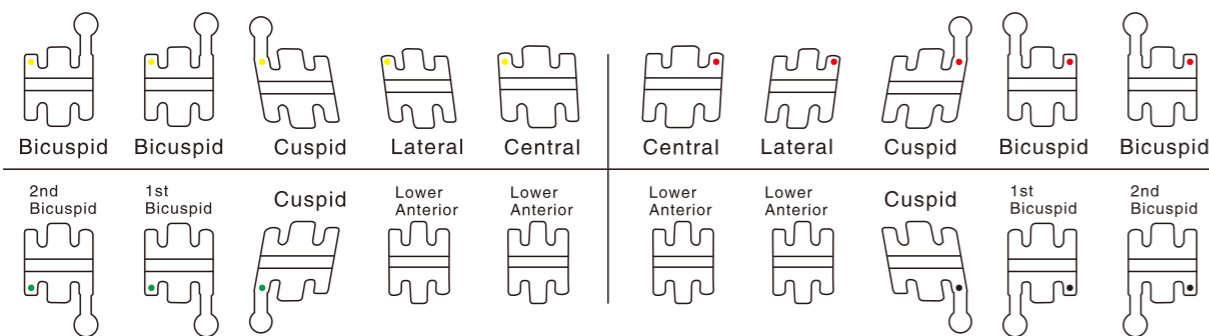

MANDIBULAR ▼	Torque	Angle	In/out	Width	0.022 with hook		0.022 no hook		
					R	L	R	L	
Lower Anterior	<u>1,2 1,2</u>	-1°	0°	1.18	2.5	TZQ2-1041	TZQ2-1031	TZQ2-1041	TZQ2-1031
Cuspid	<u>3 3</u>	-11°	5°	0.8	2.8	TZQ2-1143	TZQ2-1133	TZQ2-1043	TZQ2-1033
1st Bicuspid	<u>4 4</u>	-17°	0°	0.8	2.8	TZQ2-1144	TZQ2-1134	TZQ2-1044	TZQ2-1034
2nd Bicuspid	<u>5 5</u>	-22°	0°	0.8	2.8	TZQ2-1145	TZQ2-1135	TZQ2-1045	TZQ2-1035

Full Kits ▲▼

20pcs/kit

Kits	package	no hook	3with hook	345with hook
.022	with laser mark	TZQ2-11	TZQ2-12	TZQ2-13
	no laser mark	TZQ2-01	TZQ2-02	TZQ2-03

Light Force MBT Brackets (six-wing brackets)



MAXILLARY ▲	Torque	Angle	In/out	Width	0.022 with hook		0.022 no hook		
					R	L	R	L	
Central	<u>1 1</u>	17°	4°	0.7	3.1	TMQ2-1011	TMQ2-1021	TMQ2-1011	TMQ2-1021
Lateral	<u>2 2</u>	10°	8°	1.08	2.8	TMQ2-1012	TMQ2-1022	TMQ2-1012	TMQ2-1022
Cuspid	<u>3 3</u>	0°	8°	0.7	2.8	TMQ2-1113	TMQ2-1123	TMQ2-1013	TMQ2-1023
Bicuspid	<u>4,5 4,5</u>	-7°	0°	0.7	2.8	TMQ2-1114	TMQ2-1124	TMQ2-1014	TMQ2-1024

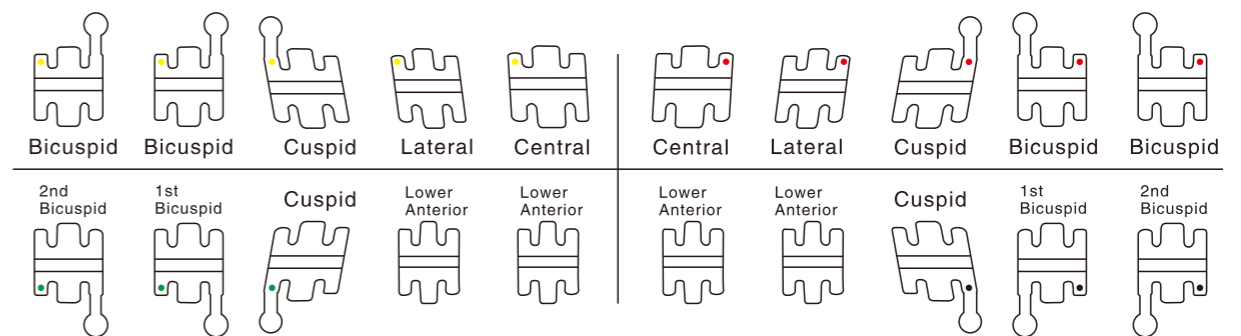

MANDIBULAR ▼	Torque	Angle	In/out	Width	0.022 with hook		0.022 no hook		
					R	L	R	L	
Lower Anterior	<u>1,2 1,2</u>	-6°	0°	0.9	2.2	TMQ2-1041	TMQ2-1031	TMQ2-1041	TMQ2-1031
Cuspid	<u>3 3</u>	0°	3°	0.7	2.8	TMQ2-1143	TMQ2-1133	TMQ2-1043	TMQ2-1033
1st Bicuspid	<u>4 4</u>	-12°	2°	0.7	2.8	TMQ2-1144	TMQ2-1134	TMQ2-1044	TMQ2-1034
2nd Bicuspid	<u>5 5</u>	-17°	2°	0.7	2.8	TMQ2-1145	TMQ2-1135	TMQ2-1045	TMQ2-1035

Full Kits ▲▼

20pcs/kit

Kits	package	no hook	3with hook	345with hook
.022	with laser mark	TMQ2-11	TMQ2-12	TMQ2-13
	no laser mark	TMQ2-01	TMQ2-02	TMQ2-03

Fashion Brackets

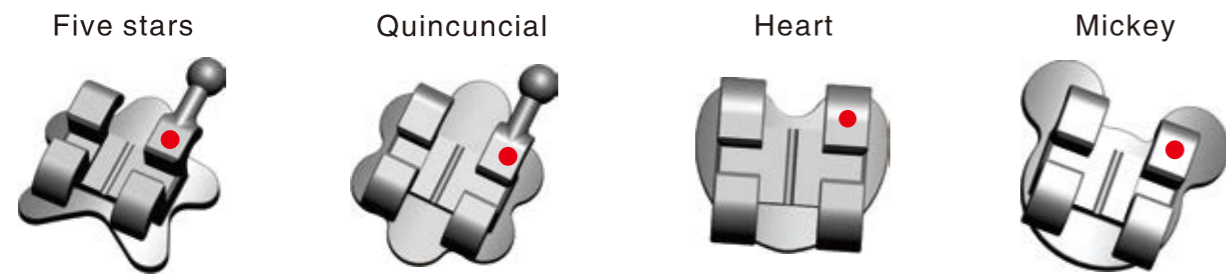

Mainly used on upper 3-3, pls specify the type and specifications.



Gold Plated Brackets

MAXILLARY ▲	Torque	Angle	In/out	Width	0.022 with hook		0.022 no hook		
					R	L	R	L	
Central	1 1	12°	5°	0.74	3.11	TG22-1011	TG22-1021	TG22-1011	TG22-1021
Lateral	2 2	8°	9°	0.72	2.8	TG22-1012	TG22-1022	TG22-1012	TG22-1022
Cuspid	3 3	-2°	11°	0.68	2.79	TG22-1113	TG22-1123	TG22-1013	TG22-1023
Bicuspid	4,5 4,5	-7°	0°	0.71	2.8	TG22-1114	TG22-1124	TG22-1014	TG22-1024

MANDIBULAR ▼	Torque	Angle	In/out	Width	0.022 with hook		0.022 no hook		
					R	L	R	L	
Lower Anterior	1,2 1,2	-1°	0°	0.65	2.4	TG22-1041	TG22-1031	TG22-1041	TG22-1031
Cuspid	3 3	-11°	5°	0.68	2.8	TG22-1143	TG22-1133	TG22-1043	TG22-1033
1st Bicuspid	4 4	-17°	0°	0.71	2.8	TG22-1144	TG22-1134	TG22-1044	TG22-1034
2nd Bicuspid	5 5	-22°	0°	0.71	2.8	TG22-1145	TG22-1135	TG22-1045	TG22-1035

Full Kits ▲▼

20pcs/kit

Kits	package	no hook	3with hook	345with hook
.022	with laser mark	TG22-11	TG22-12	TG22-13
	no laser mark	TG22-01	TG22-02	TG22-03

Note: All brackets can be gold plated

Molar Brackets

1st Molar Roth Brackets

1st Molar	Torque	Angle	In/out	Width	0.018 with hook	0.018 no hook	0.022 with hook	0.022 no hook	
UR	6	-14°	0°	1	3.8	TZ11-1116	TZ11-1016	TZ12-1116	TZ12-1016
UL	6	-14°	0°	1	3.8	TZ11-1126	TZ11-1026	TZ12-1126	TZ12-1026
LL	6	-25°	0°	1	3.8	TZ11-1136	TZ11-1036	TZ12-1136	TZ12-1036
LR	6	-25°	0°	1	3.8	TZ11-1146	TZ11-1046	TZ12-1146	TZ12-1046

1st Molar MBT Brackets

1st Molar	Torque	Angle	In/out	Width	0.018 with hook	0.018 no hook	0.022 with hook	0.022 no hook	
UR	6	-14°	0°	1	3.8	TM11-1116	TM11-1016	TM12-1116	TM12-1016
UL	6	-14°	0°	1	3.8	TM11-1126	TM11-1026	TM12-1126	TM12-1026
LL	6	-20°	0°	1	3.8	TM11-1136	TM11-1036	TM12-1136	TM12-1036
LR	6	-20°	0°	1	3.8	TM11-1146	TM11-1046	TM12-1146	TM12-1046

1st Molar Edgewise Brackets

1st Molar	Torque	Angle	In/out	Width	0.018 with hook	0.018 no hook	0.022 with hook	0.022 no hook	
UR	6	0°	0°	1	3.8	TF11-1116	TF11-1016	TF12-1116	TF12-1016
UL	6	0°	0°	1	3.8	TF11-1126	TF11-1026	TF12-1126	TF12-1026
LL	6	0°	0°	1	3.8	TF11-1136	TF11-1036	TF12-1136	TF12-1036
LR	6	0°	0°	1	3.8	TF11-1146	TF11-1046	TF12-1146	TF12-1046



Other Series Brackets >> Molar & Begg Brackets

Molar Brackets

2nd Molar Roth Brackets

1st Molar	Torque	Angle	In/out	Width	0.018 with hook	0.018 no hook	0.022 with hook	0.022 no hook	
UR	7]	-14°	0°	0.7	3.2	TZ11-1117	TZ11-1017	TZ12-1117	TZ12-1017
UL	7]	-14°	0°	0.7	3.2	TZ11-1127	TZ11-1027	TZ12-1127	TZ12-1027
LL	7]	-25°	0°	1.05	3.2	TZ11-1137	TZ11-1037	TZ12-1137	TZ12-1037
LR	7]	-25°	0°	1.05	3.2	TZ11-1147	TZ11-1047	TZ12-1147	TZ12-1047

2nd Molar MBT Brackets

1st Molar	Torque	Angle	In/out	Width	0.018 with hook	0.018 no hook	0.022 with hook	0.022 no hook	
UR	7]	-14°	0°	0.7	3.2	TM11-1117	TM11-1017	TM12-1117	TM12-1017
UL	7]	-14°	0°	0.7	3.2	TM11-1127	TM11-1027	TM12-1127	TM12-1027
LL	7]	-10°	0°	1.05	3.2	TM11-1137	TM11-1037	TM12-1137	TM12-1037
LR	7]	-10°	0°	1.05	3.2	TM11-1147	TM11-1047	TM12-1147	TM12-1047

2nd Molar Edgewise Brackets

1st Molar	Torque	Angle	In/out	Width	0.018 with hook	0.018 no hook	0.022 with hook	0.022 no hook	
UR	7]	0°	0°	1	3.2	TF11-1117	TF11-1017	TF12-1117	TF12-1017
UL	7]	0°	0°	1	3.2	TF11-1127	TF11-1027	TF12-1127	TF12-1027
LL	7]	0°	0°	1	3.2	TF11-1137	TF11-1037	TF12-1137	TF12-1037
LR	7]	0°	0°	1	3.2	TF11-1147	TF11-1047	TF12-1147	TF12-1047

Begg Brackets Bondable and weldable

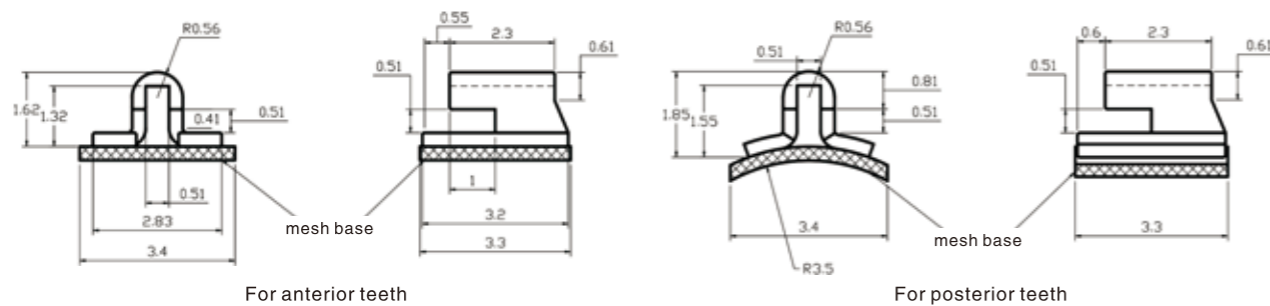

BUCCAL Tubes

MIM MONOBLOCK BUCCAL TUBES

MIM TWO PIECES BUCCAL TUBES



50 sets/box(200pcs)
F1-1 Box



20 sets/box(80pcs)
F2 Box



4 pcs/set

Bondable Buccal Tubes 72-83

1st Molar Bondable Buccal Tubes

- Single Tubes **1G**
- Single Tubes **2G**
- Single Tubes **3G**
- Single Tubes **4G**
- Single Tubes **5G**
- Single Tubes **6G**
- Single Tubes **7G**
- Single **Mini** Tubes
- Sgl Tube **with auxiliary hole**
- Sgl Tube with auxiliary hole **with Multifunctional hook**
- Q** Buccal Tubes
- Self Ligating Tubes **1G**
- Self Ligating Tubes **7G Max**
- Monoblock** Single Tubes
- Double Combination** Tubes
- Double Rectangular** Tubes
- Triple** Tubes

2nd Molar Bondable Buccal Tubes

- Single Tubes **1G**
- Single Tubes **2G**
- Single Tubes **3G**
- Single Tubes **4G**
- Q** Buccal Tubes
- Self Ligating Tubes **7G Max**
- Monoblock** Single Tubes

Weldable Buccal Tubes 83-86

1st Molar Weldable Buccal Tubes

- Single Tubes
- Double Combination Tubes
- Double Rectangular Tubes
- Triple Tubes

2nd Molar Weldable Buccal Tubes

- Single Tubes

Other Tubes

1st Molar Bondable Buccal Tubes

Single Tubes **1G** □

SYSTEM	Teeth	Torque	Offset	In/out	Width	Item No.	
						Conv	
						.018	.022
Roth	UR	-14°	10°	0.4	4	J121-1116	J121-1216
	UL	-14°	10°	0.4	4	J121-1126	J121-1226
	LL	-25°	4°	0.4	4	J121-1136	J121-1236
	LR	-25°	4°	0.4	4	J121-1146	J121-1246
MBT	UR	-14°	10°	0.4	4	J131-1116	J131-1216
	UL	-14°	10°	0.4	4	J131-1126	J131-1226
	LL	-20°	0°	0.4	4	J131-1136	J131-1236
	LR	-20°	0°	0.4	4	J131-1146	J131-1246
Edgewise	UR	0°	6°	0.4	4	J111-1116	J111-1216
	UL	0°	6°	0.4	4	J111-1126	J111-1226
	LL	0°	6°	0.4	4	J111-1136	J111-1236
	LR	0°	6°	0.4	4	J111-1146	J111-1246



Full Set: 4pcs/set

6 6 6 6 Roth	Upper	-14°	10°	0.4	4	J121-11-61	J121-12-61
	Lower	-25°	4°	0.4	4		
6 6 6 6 MBT	Upper	-14°	10°	0.4	4	J131-11-61	J131-12-61
	Lower	-20°	0°	0.4	4		
6 6 6 6 Edgewise	Upper	0°	6°	0.4	4	J111-11-61	J111-12-61
	Lower	0°	6°	0.4	4		

Single Tubes **2G** □

SYSTEM	Teeth	Torque	Offset	In/out	Width	Item No.	
						N-conv	
						.018	.022
Roth	UR	-14°	10°	0.4	4.2	J122-0116	J122-0216
	UL	-14°	10°	0.4	4.2	J122-0126	J122-0226
	LL	-25°	4°	0.4	4.2	J122-0136	J122-0236
	LR	-25°	4°	0.4	4.2	J122-0146	J122-0246
MBT	UR	-14°	10°	0.4	4.2	J132-0116	J132-0216
	UL	-14°	10°	0.4	4.2	J132-0126	J132-0226
	LL	-20°	0°	0.4	4.2	J132-0136	J132-0236
	LR	-20°	0°	0.4	4.2	J132-0146	J132-0246
Edgewise	UR	0°	6°	0.4	4.2	J112-0116	J112-0216
	UL	0°	6°	0.4	4.2	J112-0126	J112-0226
	LL	0°	6°	0.4	4.2	J112-0136	J112-0236
	LR	0°	6°	0.4	4.2	J112-0146	J112-0246



Full Set: 4pcs/set

6 6 6 6 Roth	Upper	-14°	10°	0.4	4.2	J122-01-61	J122-02-61
	Lower	-25°	4°	0.4	4.2		
6 6 6 6 MBT	Upper	-14°	10°	0.4	4.2	J132-01-61	J132-02-61
	Lower	-20°	0°	0.4	4.2		
6 6 6 6 Edgewise	Upper	0°	6°	0.4	4.2	J112-01-61	J112-02-61
	Lower	0°	6°	0.4	4.2		

Single Tubes 3G □

SYSTEM	Teeth	Torque	Offset	In/out	Width	Item No.	
						N-conv	
						.018	.022
Roth	UR	-14°	10°	0.4	4	J124-0116	J124-0216
	UL	-14°	10°	0.4	4	J124-0126	J124-0226
	LL	-25°	4°	0.4	4	J124-0136	J124-0236
	LR	-25°	4°	0.4	4	J124-0146	J124-0246
MBT	UR	-14°	10°	0.4	4	J134-0116	J134-0216
	UL	-14°	10°	0.4	4	J134-0126	J134-0226
	LL	-20°	0°	0.4	4	J134-0136	J134-0236
	LR	-20°	0°	0.4	4	J134-0146	J134-0246
Edgewise	UR	0°	6°	0.4	4	J114-0116	J114-0216
	UL	0°	6°	0.4	4	J114-0126	J114-0226
	LL	0°	6°	0.4	4	J114-0136	J114-0236
	LR	0°	6°	0.4	4	J114-0146	J114-0246



Full Set: 4pcs/set

	Upper	-14°	10°	0.4	4	J124-01-61	J124-02-61
	Lower	-25°	4°	0.4	4		
	Upper	-14°	10°	0.4	4	J134-01-61	J134-02-61
	Lower	-20°	0°	0.4	4		
	Upper	0°	6°	0.4	4	J114-01-61	J114-02-61
	Lower	0°	6°	0.4	4		

Single Tubes 4G □

SYSTEM	Teeth	Torque	Offset	In/out	Width	Item No.	
						N-conv	
						.018	.022
Roth	UR	-14°	10°	0.4	4.5	J125-0116	J125-0216
	UL	-14°	10°	0.4	4.5	J125-0126	J125-0226
	LL	-25°	4°	0.4	4.5	J125-0136	J125-0236
	LR	-25°	4°	0.4	4.5	J125-0146	J125-0246
MBT	UR	-14°	10°	0.4	4.5	J135-0116	J135-0216
	UL	-14°	10°	0.4	4.5	J135-0126	J135-0226
	LL	-20°	0°	0.4	4.5	J135-0136	J135-0236
	LR	-20°	0°	0.4	4.5	J135-0146	J135-0246
Edgewise	UR	0°	6°	0.4	4.5	J115-0116	J115-0216
	UL	0°	6°	0.4	4.5	J115-0126	J115-0226
	LL	0°	6°	0.4	4.5	J115-0136	J115-0236
	LR	0°	6°	0.4	4.5	J115-0146	J115-0246



Full Set: 4pcs/set

	Upper	-14°	10°	0.4	4.5	J125-01-61	J125-02-61
	Lower	-25°	4°	0.4	4.5		
	Upper	-14°	10°	0.4	4.5	J135-01-61	J135-02-61
	Lower	-20°	0°	0.4	4.5		
	Upper	0°	6°	0.4	4.5	J115-01-61	J115-02-61
	Lower	0°	6°	0.4	4.5		

Single Tubes 5G □

SYSTEM	Teeth	Torque	Offset	In/out	Width	Item No.	
						N-conv	
						.018	.022
Roth	UR	-14°	10°	0.4	3.5	J126-0116	J126-0216
	UL	-14°	10°	0.4	3.5	J126-0126	J126-0226
	LL	-25°	4°	0.4	3.5	J126-0136	J126-0236
	LR	-25°	4°	0.4	3.5	J126-0146	J126-0246
MBT	UR	-14°	10°	0.4	3.5	J136-0116	J136-0216
	UL	-14°	10°	0.4	3.5	J136-0126	J136-0226
	LL	-20°	0°	0.4	3.5	J136-0136	J136-0236
	LR	-20°	0°	0.4	3.5	J136-0146	J136-0246
Edgewise	UR	0°	6°	0.4	3.5	J116-0116	J116-0216
	UL	0°	6°	0.4	3.5	J116-0126	J116-0226
	LL	0°	6°	0.4	3.5	J116-0136	J116-0236
	LR	0°	6°	0.4	3.5	J116-0146	J116-0246



Full Set: 4pcs/set

	Upper	-14°	10°	0.4	3.5	J126-01-61	J126-02-61
	Lower	-25°	4°	0.4	3.5		
	Upper	-14°	10°	0.4	3.5	J136-01-61	J136-02-61
	Lower	-20°	0°	0.4	3.5		
	Upper	0°	6°	0.4	3.5	J116-01-61	J116-02-61
	Lower	0°	6°	0.4	3.5		

Single Tubes 6G □

SYSTEM	Teeth	Torque	Offset	In/out	Width	Item No.	
						N-conv	
						.018	.022
Roth	UR	-14°	10°	0.4	4.2	J127-0116	J127-0216
	UL	-14°	10°	0.4	4.2	J127-0126	J127-0226
	LL	-25°	4°	0.4	4.2	J127-0136	J127-0236
	LR	-25°	4°	0.4	4.2	J127-0146	J127-0246
MBT	UR	-14°	10°	0.4	4.2	J137-0116	J137-0216
	UL	-14°	10°	0.4	4.2	J137-0126	J137-0226
	LL	-20°	0°	0.4	4.2	J137-0136	J137-0236
	LR	-20°	0°	0.4	4.2	J137-0146	J137-0246
Edgewise	UR	0°	6°	0.4	4.2	J117-0116	J117-0216
	UL	0°	6°	0.4	4.2	J117-0126	J117-0226
	LL	0°	6°	0.4	4.2	J117-0136	J117-0236
	LR	0°	6°	0.4	4.2	J117-0146	J117-0246



Full Set: 4pcs/set

	Upper	-14°	10°	0.4	4.2	J127-01-61	J127-02-61
	Lower	-25°	4°	0.4	4.2		
	Upper	-14°	10°	0.4	4.2	J137-01-61	J137-02-61
	Lower	-20°	0°	0.4	4.2		
	Upper	0°	6°	0.4	4.2	J117-01-61	J117-02-61
	Lower	0°	6°	0.4	4.2		

Single Tubes 7G □

Round/Rect tube	Item No.
0.025"	J141-01
0.025*0.019"	J141-02
0.019*0.025"	J141-03



Single Mini Tubes □

Explanation:
This tube can be used for cases with small crowns and tight bite, regardless of any tooth position, aperture 0.52mm

Item No.
J142-01



Sgl Tube with auxiliary hole □

SYSTEM	Teeth	Torque	Offset	In/out	Width	Item No.	
						N-conv	
						.018	.022
Roth	UR	-14°	10°	0.4	4	J521-0116	J521-0216
	UL	-14°	10°	0.4	4	J521-0126	J521-0226
	LL	-25°	4°	0.4	4	J521-0136	J521-0236
	LR	-25°	4°	0.4	4	J521-0146	J521-0246
MBT	UR	-14°	10°	0.4	4	J531-0116	J531-0216
	UL	-14°	10°	0.4	4	J531-0126	J531-0226
	LL	-20°	0°	0.4	4	J531-0136	J531-0236
	LR	-20°	0°	0.4	4	J531-0146	J531-0246



Full Set: 4pcs/set

$\frac{6}{6} \frac{6}{6}$ Roth	Upper	-14°	10°	0.4	4	J521-01-61	J521-02-61
	Lower	-25°	4°	0.4	4		
$\frac{6}{6} \frac{6}{6}$ MBT	Upper	-14°	10°	0.4	4	J531-01-61	J531-02-61
	Lower	-20°	0°	0.4	4		

Sgl Tube with auxiliary hole with Multifunctional hook □

Teeth	Torque	Offset	In/out	Width	Item No.	
					N-conv	
					.022	
UR	-14°	10°	0.4	4	J522-0216	
UL	-14°	10°	0.4	4	J522-0226	
LL	-15°	0°	0.4	4	J522-0236	
LR	-15°	0°	0.4	4	J522-0246	

Full Set: 4pcs/set

$\frac{6.7}{6.7} \frac{6.7}{6.7}$	Upper	-14°	10°	0.4	4	J522-02-61
	Lower	-15°	0°	0.4	4	



Q Buccal Tubes □

SYSTEM	Teeth	Torque	Offset	In/out	Width	Item No.	
						N-conv	
						.018	.022
Roth	UR	-14°	10°	0.4	4	J12Q-0116	J12Q-0216
	UL	-14°	10°	0.4	4	J12Q-0126	J12Q-0226
	LL	-25°	4°	0.4	4	J12Q-0136	J12Q-0236
	LR	-25°	4°	0.4	4	J12Q-0146	J12Q-0246
MBT	UR	-14°	10°	0.4	4	J13Q-0116	J13Q-0216
	UL	-14°	10°	0.4	4	J13Q-0126	J13Q-0226
	LL	-20°	0°	0.4	4	J13Q-0136	J13Q-0236
	LR	-20°	0°	0.4	4	J13Q-0146	J13Q-0246



Full Set: 4pcs/set

$\frac{6}{6} \frac{6}{6}$ Roth	Upper	-14°	10°	0.4	4	J12Q-01-61	J12Q-02-61
	Lower	-25°	4°	0.4	4		
$\frac{6}{6} \frac{6}{6}$ MBT	Upper	-14°	10°	0.4	4	J13Q-01-61	J13Q-02-61
	Lower	-20°	0°	0.4	4		

Self Ligating Tubes 1G □

SYSTEM	Teeth	Torque	Offset	In/out	Width	Item No.	
						N-conv	
						.022	
Roth	UR	-14°	10°	0.4	4	J128-0216	
	UL	-14°	10°	0.4	4	J128-0226	
	LL	-25°	4°	0.4	4	J128-0236	
	LR	-25°	4°	0.4	4	J128-0246	
MBT	UR	-14°	10°	0.4	4	J138-0216	
	UL	-14°	10°	0.4	4	J138-0226	
	LL	-20°	0°	0.4	4	J138-0236	
	LR	-20°	0°	0.4	4	J138-0246	



Full Set: 4pcs/set

$\frac{6}{6} \frac{6}{6}$ Roth	Upper	-14°	10°	0.4	4	J128-02-61
	Lower	-25°	4°	0.4	4	
$\frac{6}{6} \frac{6}{6}$ MBT	Upper	-14°	10°	0.4	4	J138-02-61
	Lower	-20°	0°	0.4	4	

Self Ligating Tubes 7G Max □

SYSTEM	Teeth	Torque	Offset	In/out	Width	Item No.	
						N-conv	
						.018	.022
Roth	UR	-14°	10°	0.4	4	J129-0216	
	UL	-14°	10°	0.4	4	J129-0226	
	LL	-25°	4°	0.4	4	J129-0236	
	LR	-25°	4°	0.4	4	J129-0246	
MBT	UR	-14°	10°	0.4	4	J139-0216	
	UL	-14°	10°	0.4	4	J139-0226	
	LL	-20°	0°	0.4	4	J139-0236	
	LR	-20°	0°	0.4	4	J139-0246	



Full Set: 4pcs/set

SYSTEM	Teeth	Torque	Offset	In/out	Width	Item No.	
						N-conv	.022
Roth	Upper	-14°	10°	0.4	4	J129-02-61	
	Lower	-25°	4°	0.4	4		
MBT	Upper	-14°	10°	0.4	4	J139-02-61	
	Lower	-20°	0°	0.4	4		

Monoblock Single Tubes □

SYSTEM	Teeth	Torque	Offset	In/out	Width	Item No.	
						N-conv	
						.018	.022
Roth	UR	-14°	10°	0.4	4	J123-0116	J123-0216
	UL	-14°	10°	0.4	4	J123-0126	J123-0226
	LL	-25°	4°	0.4	4	J123-0136	J123-0236
	LR	-25°	4°	0.4	4	J123-0146	J123-0246
MBT	UR	-14°	10°	0.4	4	J133-0116	J133-0216
	UL	-14°	10°	0.4	4	J133-0126	J133-0226
	LL	-20°	0°	0.4	4	J133-0136	J133-0236
	LR	-20°	0°	0.4	4	J133-0146	J133-0246
Edgewise	UR	0°	6°	0.4	4	J113-0116	J113-0216
	UL	0°	6°	0.4	4	J113-0126	J113-0226
	LL	0°	6°	0.4	4	J113-0136	J113-0236
	LR	0°	6°	0.4	4	J113-0146	J113-0246



Full Set: 4pcs/set

SYSTEM	Teeth	Torque	Offset	In/out	Width	Item No.	
						N-conv	.022
Roth	Upper	-14°	10°	0.4	4	J123-01-61	J123-02-61
	Lower	-25°	4°	0.4	4		
MBT	Upper	-14°	10°	0.4	4	J133-01-61	J133-02-61
	Lower	-20°	0°	0.4	4		
Edgewise	Upper	0°	6°	0.4	4	J113-01-61	J113-02-61
	Lower	0°	6°	0.4	4		

Double Combination Tubes □/□

SYSTEM	Teeth	Torque	Offset	In/out	Width	Item No.			
						Conv		N-conv	
						.018	.022	.018	.022
Roth	UR	-14°	10°	0.4	4	J221-1116	J221-1216	J221-0116	J221-0216
	UL	-14°	10°	0.4	4	J221-1126	J221-1226	J221-0126	J221-0226
MBT	UR	-14°	10°	0.4	4	J231-1116	J231-1216	J231-0116	J231-0216
	UL	-14°	10°	0.4	4	J231-1126	J231-1226	J231-0126	J231-0226
Edgewise	UR	0°	6°	0.4	4	J211-1116	J211-1216	J211-0116	J211-0216
	UL	0°	6°	0.4	4	J211-1126	J211-1226	J211-0126	J211-0226



Full Set: 4pcs/set

SYSTEM	Teeth	Torque	Offset	In/out	Width	Item No.			
						Conv	N-conv	.018	.022
Roth	Upper	-14°	10°	0.4	4	J221-11-61	J221-12-61	J221-01-61	J221-02-61
	Lower	-25°	4°	0.4	4				
MBT	Upper	-14°	10°	0.4	4	J231-11-61	J231-12-61	J231-01-61	J231-02-61
	Lower	-20°	0°	0.4	4				
Edgewise	Upper	0°	6°	0.4	4	J211-11-61	J211-12-61	J211-01-61	J211-02-61
	Lower	0°	6°	0.4	4				



Double Rectangular Tubes □/□

SYSTEM	Teeth	Torque	Offset	In/out	Width	Item No.			
						Conv		N-conv	
						.018	.022	.018	.022
Roth	UR	-14°	10°	0.4	4	J421-1116	J421-1216	J421-0116	J421-0216
	UL	-14°	10°	0.4	4	J421-1126	J421-1226	J421-0126	J421-0226
	LL	-25°	4°	0.4	4	J421-1136	J421-1236	J421-0136	J421-0236
	LR	-25°	4°	0.4	4	J421-1146	J421-1246	J421-0146	J421-0246
MBT	UR	-14°	10°	0.4	4	J431-1116	J431-1216	J431-0116	J431-0216
	UL	-14°	10°	0.4	4	J431-1126	J431-1226	J431-0126	J431-0226
	LL	-20°	0°	0.4	4	J431-1136	J431-1236	J431-0136	J431-0236
	LR	-20°	0°	0.4	4	J431-1146	J431-1246	J431-0146	J431-0246
Edgewise	UR	0°	6°	0.4	4	J411-1116	J411-1216	J411-0116	J411-0216
	UL	0°	6°	0.4	4	J411-1126	J411-1226	J411-0126	J411-0226
	LL	0°	6°	0.4	4	J411-1136	J411-1236	J411-0136	J411-0236
	LR	0°	6°	0.4	4	J411-1146	J411-1246	J411-0146	J411-0246



Full Set: 4pcs/set

SYSTEM	Teeth	Torque	Offset	In/out	Width	Item No.			
						Conv	N-conv	.018	.022
Roth	Upper	-14°	10°	0.4	4	J421-11-61	J421-12-61	J421-01-61	J421-02-61
	Lower	-25°	4°	0.4	4				
MBT	Upper	-14°	10°	0.4	4	J431-11-61	J431-12-61	J431-01-61	J431-02-61
	Lower	-20°	0°	0.4	4				
Edgewise	Upper	0°	6°	0.4	4	J411-11-61	J411-12-61	J411-01-61	J411-02-61
	Lower	0°	6°	0.4	4				

Bondable >> 1st Molar Bondable Buccal Tubes

Bondable >> 2nd Molar Bondable Buccal Tubes

Triple Tubes □□□/□□□

SYSTEM	Teeth	Torque	Offset	In/out	Width	Item No.	
						Conv	
						.018	.022
Roth	UR	-14°	10°	0.4	4	J321-1116	J321-1216
	UL	-14°	10°	0.4	4	J321-1126	J321-1226
MBT	UR	-14°	10°	0.4	4	J331-1116	J331-1216
	UL	-14°	10°	0.4	4	J331-1126	J331-1226
Edgewise	UR	0°	6°	0.4	4	J311-1116	J311-1216
	UL	0°	6°	0.4	4	J311-1126	J311-1226



Full Set: 4pcs/set

$\frac{6}{6} \frac{6}{6}$ Roth	Upper	-14°	10°	0.4	4	J321-11-61	J321-12-61
	Lower	-25°	4°	0.4	4		
$\frac{6}{6} \frac{6}{6}$ MBT	Upper	-14°	10°	0.4	4	J331-11-61	J331-12-61
	Lower	-20°	0°	0.4	4		
$\frac{6}{6} \frac{6}{6}$ Edgewise	Upper	0°	6°	0.4	4	J311-11-61	J311-12-61
	Lower	0°	6°	0.4	4		



2nd Molar Bondable Buccal Tubes

Single Tubes 1G □

SYSTEM	Teeth	Torque	Offset	In/out	Width	Item No.	
						N-conv	
						.018	.022
Roth	UR	-14°	10°	0.4	3.2	J121-0117	J121-0217
	UL	-14°	10°	0.4	3.2	J121-0127	J121-0227
	LL	-25°	4°	0.4	3.2	J121-0137	J121-0237
	LR	-25°	4°	0.4	3.2	J121-0147	J121-0247
MBT	UR	-14°	10°	0.4	3.2	J131-0117	J131-0217
	UL	-14°	10°	0.4	3.2	J131-0127	J131-0227
	LL	-10°	0°	0.4	3.2	J131-0137	J131-0237
	LR	-10°	0°	0.4	3.2	J131-0147	J131-0247
Edgewise	UR	0°	6°	0.4	3.2	J111-0117	J111-0217
	UL	0°	6°	0.4	3.2	J111-0127	J111-0227
	LL	0°	6°	0.4	3.2	J111-0137	J111-0237
	LR	0°	6°	0.4	3.2	J111-0147	J111-0247



Full Set: 4pcs/set

$\frac{7}{7} \frac{7}{7}$ Roth	Upper	-14°	10°	0.4	3.2	J121-01-71	J121-02-71
	Lower	-25°	4°	0.4	3.2		
$\frac{7}{7} \frac{7}{7}$ MBT	Upper	-14°	10°	0.4	3.2	J131-01-71	J131-02-71
	Lower	-10°	0°	0.4	3.2		
$\frac{7}{7} \frac{7}{7}$ Edgewise	Upper	0°	6°	0.4	3.2	J111-01-71	J111-02-71
	Lower	0°	6°	0.4	3.2		

Single Tubes 2G □

SYSTEM	Teeth	Torque	Offset	In/out	Width	Item No.	
						N-conv	
						.018	.022
Roth	UR	-14°	10°	0.4	3.2	J122-0117	J122-0217
	UL	-14°	10°	0.4	3.2	J122-0127	J122-0227
	LL	-25°	4°	0.4	3.2	J122-0137	J122-0237
	LR	-25°	4°	0.4	3.2	J122-0147	J122-0247
MBT	UR	-14°	10°	0.4	3.2	J132-0117	J132-0217
	UL	-14°	10°	0.4	3.2	J132-0127	J132-0227
	LL	-10°	0°	0.4	3.2	J132-0137	J132-0237
	LR	-10°	0°	0.4	3.2	J132-0147	J132-0247
Edgewise	UR	0°	6°	0.4	3.2	J112-0117	J112-0217
	UL	0°	6°	0.4	3.2	J112-0127	J112-0227
	LL	0°	6°	0.4	3.2	J112-0117	J112-0217
	LR	0°	6°	0.4	3.2	J112-0127	J112-0227



(Roth / MBT)



(Edgewise)

Full Set: 4pcs/set

$\frac{7}{7} \frac{7}{7}$ Roth	Upper	-14°	10°	0.4	3.2	J122-01-71	J122-02-71
	Lower	-25°	4°	0.4	3.2		
$\frac{7}{7} \frac{7}{7}$ MBT	Upper	-14°	10°	0.4	3.2	J132-01-71	J132-02-71
	Lower	-10°	0°	0.4	3.2		
$\frac{7}{7} \frac{7}{7}$ Edgewise	Upper	0°	6°	0.4	3.2	J112-01-71	J112-02-71
	Lower	0°	6°	0.4	3.2		

Single Tubes 3G □

SYSTEM	Teeth	Torque	Offset	In/out	Width	Item No.	
						N-conv	
						.018	.022
Roth	UR	-14°	10°	0.4	3.2	J124-0117	J124-0217
	UL	-14°	10°	0.4	3.2	J124-0127	J124-0227
	LL	-25°	4°	0.4	3.2	J124-0137	J124-0237
	LR	-25°	4°	0.4	3.2	J124-0147	J124-0247
MBT	UR	-14°	10°	0.4	3.2	J134-0117	J134-0217
	UL	-14°	10°	0.4	3.2	J134-0127	J134-0227
	LL	-10°	0°	0.4	3.2	J134-0137	J134-0237
	LR	-10°	0°	0.4	3.2	J134-0147	J134-0247
Edgewise	UR	0°	6°	0.4	3.2	J114-0117	J114-0217
	UL	0°	6°	0.4	3.2	J114-0127	J114-0227
	LL	0°	6°	0.4	3.2	J114-0137	J114-0237
	LR	0°	6°	0.4	3.2	J114-0147	J114-0247



Full Set: 4pcs/set

7 7 7 7 Roth	Upper	-14°	10°	0.4	3.2	J124-01-71	J124-02-71
	Lower	-25°	4°	0.4	3.2		
7 7 7 7 MBT	Upper	-14°	10°	0.4	3.2	J134-01-71	J134-02-71
	Lower	-10°	0°	0.4	3.2		
7 7 7 7 Edgewise	Upper	0°	6°	0.4	3.2	J114-01-71	J114-02-71
	Lower	0°	6°	0.4	3.2		

Single Tubes 4G □

SYSTEM	Teeth	Torque	Offset	In/out	Width	Item No.	
						N-conv	
						.018	.022
Roth	UR	-14°	10°	0.4	3.2	J125-0117	J125-0217
	UL	-14°	10°	0.4	3.2	J125-0127	J125-0227
	LL	-25°	4°	0.4	3.2	J125-0137	J125-0237
	LR	-25°	4°	0.4	3.2	J125-0147	J125-0247
MBT	UR	-14°	10°	0.4	3.2	J135-0117	J135-0217
	UL	-14°	10°	0.4	3.2	J135-0127	J135-0227
	LL	-10°	0°	0.4	3.2	J135-0137	J135-0237
	LR	-10°	0°	0.4	3.2	J135-0147	J135-0247
Edgewise	UR	0°	6°	0.4	3.2	J115-0117	J115-0217
	UL	0°	6°	0.4	3.2	J115-0127	J115-0227
	LL	0°	6°	0.4	3.2	J115-0137	J115-0237
	LR	0°	6°	0.4	3.2	J115-0147	J115-0247



Full Set: 4pcs/set

7 7 7 7 Roth	Upper	-14°	10°	0.4	3.2	J125-01-71	J125-02-71
	Lower	-25°	4°	0.4	3.2		
7 7 7 7 MBT	Upper	-14°	10°	0.4	3.2	J135-01-71	J135-02-71
	Lower	-10°	0°	0.4	3.2		
7 7 7 7 Edgewise	Upper	0°	6°	0.4	3.2	J115-01-71	J115-02-71
	Lower	0°	6°	0.4	3.2		

Q Buccal Tubes □

SYSTEM	Teeth	Torque	Offset	In/out	Width	Item No.	
						N-conv	
						.018	.022
Roth	UR	-14°	10°	0.4	3.2	J12Q-0117	J12Q-0217
	UL	-14°	10°	0.4	3.2	J12Q-0127	J12Q-0227
	LL	-25°	4°	0.4	3.2	J12Q-0137	J12Q-0237
	LR	-25°	4°	0.4	3.2	J12Q-0147	J12Q-0247
MBT	UR	-14°	10°	0.4	3.2	J13Q-0117	J13Q-0217
	UL	-14°	10°	0.4	3.2	J13Q-0127	J13Q-0227
	LL	-10°	0°	0.4	3.2	J13Q-0137	J13Q-0237
	LR	-10°	0°	0.4	3.2	J13Q-0147	J13Q-0247



Full Set: 4pcs/set

7 7 7 7 Roth	Upper	-14°	10°	0.4	3.2	J12Q-01-71	J12Q-02-71
	Lower	-25°	4°	0.4	3.2		
7 7 7 7 MBT	Upper	-14°	10°	0.4	3.2	J13Q-01-71	J13Q-02-71
	Lower	-10°	0°	0.4	3.2		

Self Ligating Tubes 7G Max □

SYSTEM	Teeth	Torque	Offset	In/out	Width	Item No.	
						N-conv	
						.018	.022
Roth	UR	-14°	10°	0.4	3.2	J129-0217	
	UL	-14°	10°	0.4	3.2	J129-0227	
	LL	-25°	4°	0.4	3.2	J129-0237	
	LR	-25°	4°	0.4	3.2	J129-0247	
MBT	UR	-14°	10°	0.4	3.2	J139-0217	
	UL	-14°	10°	0.4	3.2	J139-0227	
	LL	-20°	0°	0.4	3.2	J139-0237	
	LR	-20°	0°	0.4	3.2	J139-0247	



Full Set: 4pcs/set

7 7 7 7 Roth	Upper	-14°	10°	0.4	3.2	J129-02-71
	Lower	-25°	4°	0.4	3.2	
7 7 7 7 MBT	Upper	-14°	10°	0.4	3.2	J139-02-71
	Lower	-20°	0°	0.4	3.2	

Monoblock Single Tubes □

SYSTEM	Teeth	Torque	Offset	In/out	Width	Item No.	
						N-conv	
						.018	.022
Roth	UR	-14°	10°	0.4	3.2	J123-0117	J123-0217
	UL	-14°	10°	0.4	3.2	J123-0127	J123-0227
	LL	-25°	4°	0.4	3.2	J123-0137	J123-0237
	LR	-25°	4°	0.4	3.2	J123-0147	J123-0247
MBT	UR	-14°	10°	0.4	3.2	J133-0117	J133-0217
	UL	-14°	10°	0.4	3.2	J133-0127	J133-0227
	LL	-10°	0°	0.4	3.2	J133-0137	J133-0237
	LR	-10°	0°	0.4	3.2	J133-0147	J133-0247



Full Set: 4pcs/set

7 7 7 7 Roth	Upper	-14°	10°	0.4	3.2	J123-01-71	J123-02-71
	Lower	-25°	4°	0.4	3.2		
7 7 7 7 MBT	Upper	-14°	10°	0.4	3.2	J133-01-71	J133-02-71
	Lower	-10°	0°	0.4	3.2		

1st molar 80 mesh bottom size selections:

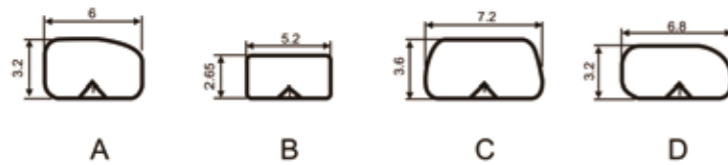

Usually Choose Size A

2nd molar 80 mesh bottom size selections:



Usually Choose Size A

1st Molar Weldable Buccal Tubes

Single Tubes □

SYSTEM	Teeth	Torque	Offset	In/out	Width	Item No.			
						Conv		N-conv	
						.018	.022	.018	.022
Roth	UR	-14°	10°	0.4	4	J120-1116	J120-1216	J120-0116	J120-0216
	UL	-14°	10°	0.4	4	J120-1126	J120-1226	J120-0126	J120-0226
	LL	-25°	4°	0.4	4	J120-1136	J120-1236	J120-0136	J120-0236
	LR	-25°	4°	0.4	4	J120-1146	J120-1246	J120-0146	J120-0246
MBT	UR	-14°	10°	0.4	4	J130-1116	J130-1216	J130-0116	J130-0216
	UL	-14°	10°	0.4	4	J130-1126	J130-1226	J130-0126	J130-0226
	LL	-20°	0°	0.4	4	J130-1136	J130-1236	J130-0136	J130-0236
	LR	-20°	0°	0.4	4	J130-1146	J130-1246	J130-0146	J130-0246
Edgewise	UR	0°	6°	0.4	4	J110-1116	J110-1216	J110-0116	J110-0216
	UL	0°	6°	0.4	4	J110-1126	J110-1226	J110-0126	J110-0226
	LL	0°	6°	0.4	4	J110-1136	J110-1236	J110-0136	J110-0236
	LR	0°	6°	0.4	4	J110-1146	J110-1246	J110-0146	J110-0246



Full Set: 4pcs/set

6 6 6 6 Roth	Upper	-14°	10°	0.4	4	J120-11-61	J120-12-61	J120-01-61	J120-02-61
	Lower	-25°	4°	0.4	4				
6 6 6 6 MBT	Upper	-14°	10°	0.4	4	J130-11-61	J130-12-61	J130-01-61	J130-02-61
	Lower	-20°	0°	0.4	4				
6 6 6 6 Edgewise	Upper	0°	6°	0.4	4	J110-11-61	J110-12-61	J110-01-61	J110-02-61
	Lower	0°	6°	0.4	4				

Double Combination Tubes □/□

SYSTEM	Teeth	Torque	Offset	In/out	Width	Item No.			
						Conv		N-conv	
						.018	.022	.018	.022
Roth	UR	-14°	10°	0.4	4	J220-1116	J220-1216	J220-0116	J220-0216
	UL	-14°	10°	0.4	4	J220-1126	J220-1226	J220-0126	J220-0226
MBT	UR	-14°	10°	0.4	4	J230-1116	J230-1216	J230-0116	J230-0216
	UL	-14°	10°	0.4	4	J230-1126	J230-1226	J230-0126	J230-0226
Edgewise	UR	0°	6°	0.4	4	J210-1116	J210-1216	J210-0116	J210-0216
	UL	0°	6°	0.4	4	J210-1126	J210-1226	J210-0126	J210-0226

Full Set: 4pcs/set

6 6 6 6 Roth	Upper	-14°	10°	0.4	4	J220-11-61	J220-12-61	J220-01-61	J220-02-61
	Lower	-25°	4°	0.4	4				
6 6 6 6 MBT	Upper	-14°	10°	0.4	4	J230-11-61	J230-12-61	J230-01-61	J230-02-61
	Lower	-20°	0°	0.4	4				
6 6 6 6 Edgewise	Upper	0°	6°	0.4	4	J210-11-61	J210-12-61	J210-01-61	J210-02-61
	Lower	0°	6°	0.4	4				



Double Rectangular Tubes □□/□□

SYSTEM	Teeth	Torque	Offset	In/out	Width	Item No.	
						Conv	
						.018	.022
Roth	UR	-14°	10°	0.4	4	J420-1116	J420-1216
	UL	-14°	10°	0.4	4	J420-1126	J420-1226
	LL	-25°	4°	0.4	4	J420-1136	J420-1236
	LR	-25°	4°	0.4	4	J420-1146	J420-1246
MBT	UR	-14°	10°	0.4	4	J430-1116	J430-1216
	UL	-14°	10°	0.4	4	J430-1126	J430-1226
	LL	-20°	0°	0.4	4	J430-1136	J430-1236
	LR	-20°	0°	0.4	4	J430-1146	J430-1246
Edgewise	UR	0°	6°	0.4	4	J410-1116	J410-1216
	UL	0°	6°	0.4	4	J410-1126	J410-1226
	LL	0°	6°	0.4	4	J410-1136	J410-1236
	LR	0°	6°	0.4	4	J410-1146	J410-1246



Full Set: 4pcs/set

6 6 6 6 Roth	Upper	-14°	10°	0.4	4	J420-11-61	J420-12-61
	Lower	-25°	4°	0.4	4		
6 6 6 6 MBT	Upper	-14°	10°	0.4	4	J430-11-61	J430-12-61
	Lower	-20°	0°	0.4	4		
6 6 6 6 Edgewise	Upper	0°	6°	0.4	4	J410-11-61	J410-12-61
	Lower	0°	6°	0.4	4		

Triple Tubes □□□/□□□

SYSTEM	Teeth	Torque	Offset	In/out	Width	Item No.	
						Conv	
						.018	.022
Roth	UR	-14°	10°	0.4	4	J320-1116	J320-1216
	UL	-14°	10°	0.4	4	J320-1126	J320-1226
MBT	UR	-14°	10°	0.4	4	J330-1116	J330-1216
	UL	-14°	10°	0.4	4	J330-1126	J330-1226
Edgewise	UR	0°	6°	0.4	4	J310-1116	J310-1216
	UL	0°	6°	0.4	4	J310-1126	J310-1226



Full Set: 4pcs/set

6 6 6 6 Roth	Upper	-14°	10°	0.4	4	J320-11-61	J320-12-61
	Lower	-25°	4°	0.4	4		
6 6 6 6 MBT	Upper	-14°	10°	0.4	4	J330-11-61	J330-12-61
	Lower	-20°	0°	0.4	4		
6 6 6 6 Edgewise	Upper	0°	6°	0.4	4	J310-11-61	J310-12-61
	Lower	0°	6°	0.4	4		

2nd Molar Weldable Buccal Tubes

Single Tubes □

SYSTEM	Teeth	Torque	Offset	In/out	Width	Item No.	
						N-conv	
						.018	.022
Roth	UR	-14°	10°	0.4	3.2	J120-0117	J120-0217
	UL	-14°	10°	0.4	3.2	J120-0127	J120-0227
	LL	-25°	4°	0.4	3.2	J120-0137	J120-0237
	LR	-25°	4°	0.4	3.2	J120-0147	J120-0247
MBT	UR	-14°	10°	0.4	3.2	J130-0117	J130-0217
	UL	-14°	10°	0.4	3.2	J130-0127	J130-0227
	LL	-10°	0°	0.4	3.2	J130-0137	J130-0237
	LR	-10°	0°	0.4	3.2	J130-0147	J130-0247
Edgewise	UR	0°	6°	0.4	3.2	J110-0117	J110-0217
	UL	0°	6°	0.4	3.2	J110-0127	J110-0227
	LL	0°	6°	0.4	3.2	J110-0137	J110-0237
	LR	0°	6°	0.4	3.2	J110-0147	J110-0247



Full Set: 4pcs/set

7 7 7 7 Roth	Upper	-14°	10°	0.4	3.2	J120-01-71	J120-02-71
	Lower	-25°	4°	0.4	3.2		
7 7 7 7 MBT	Upper	-14°	10°	0.4	3.2	J130-01-71	J130-02-71
	Lower	-20°	0°	0.4	3.2		
7 7 7 7 Edgewise	Upper	0°	6°	0.4	3.2	J110-01-71	J110-02-71
	Lower	0°	6°	0.4	3.2		

Other Tubes

Begg Buccal Tubes: Weldable, Bondable

SYSTEM	Teeth	Torque	Offset	In/out	Width
Roth	Upper	7°	0°	0.4	3
	Lower	17°	0°	0.4	3
Edgewise	Upper	0°	0°	0.4	3
	Lower	0°	0°	0.4	3



Bicuspid Buccal Tubes: Bondable

Teeth	Torque	Offset	In/out	Width
Upper	0°	0°	0.4	4.5



Bands



Bands with Single tubes



Bands with Dbl Combination tubes



Bands with Dbl Rectangular tubes



Bands with Triple tubes



Bands with Bicuspid brackets



Space Maintainer



G1 85 sets/box(340pcs)



G3 20 sets/box(80pcs)



4 pcs/set

Plain bands

89-95

1. Bicuspid Plain bands
2. Bicuspid L series Plain bands
3. 1st molar M series Plain bands
4. 1st molar G series Plain bands
5. 2nd molar M series Plain bands
6. 2nd molar G series Plain bands

Preweld bands

96-109

- 1. Bicuspid bands Pre-welded with brackets**
 - Hook&No Hook; Roth\MBT\Edgewise Brackets
- 2. Bicuspid L series bands Pre-welded with brackets**
 - Hook&No Hook; Roth\MBT\Edgewise Brackets
- 3. 1st molar M series bands Pre-welded with tubes**
 - a.Pre-welded with single tubes
 - Conv & N-Conv; Roth\MBT\Edgewise Tubes
 - b.Pre-welded with double combination tubes
 - Conv & N-Conv; Roth\MBT\Edgewise Tubes
 - c.Pre-welded with double rectangular tubes
 - Conv; Roth\MBT\Edgewise Tubes
 - d.Pre-welded with triple tubes
 - Conv; Roth\MBT\Edgewise Tubes
- 4. 1st molar G series bands Pre-welded with tubes**
 - a.Pre-welded with single tubes
 - Conv & N-Conv; Roth\MBT\Edgewise Tubes
 - b.Pre-welded with double combination tubes
 - Conv & N-Conv; Roth\MBT\Edgewise Tubes
 - c.Pre-welded with double rectangular tubes
 - Conv; Roth\MBT\Edgewise Tubes
 - d.Pre-welded with triple tubes
 - Conv; Roth\MBT\Edgewise Tubes
- 5. 2nd molar M series bands Pre-welded with tubes**
 - Pre-welded with single tubes
 - N-Conv; Roth\MBT\Edgewise Tubes
- 6. 2nd molar G series bands Pre-welded with tubes**
 - Pre-welded with single tubes
 - N-Conv; Roth\MBT\Edgewise Tubes

Space Maintainer

110-114

Advantages:

1. The shape of band accord to the shape of molar, using computer simulation technology to ensure fitting closely with the teeth;
2. Imported fine stainless steel material provide uniform thickness and moderate hardness;
3. Clear, permanent laser mark, never disappear and fade, easy to identify for dentists;
4. Involute edge provide a close fit with the teeth, enhance the stability, and prevent the loss of the adhesive and into particles;
5. Sandblasted inner surface increasing the contact area provide 40% more adhesive strength;
6. Yahong band has six series: Bicuspid series, Bicuspid L series, 1st molar M series, 1st molar G series, 2nd molar M series, 2nd molar G series.

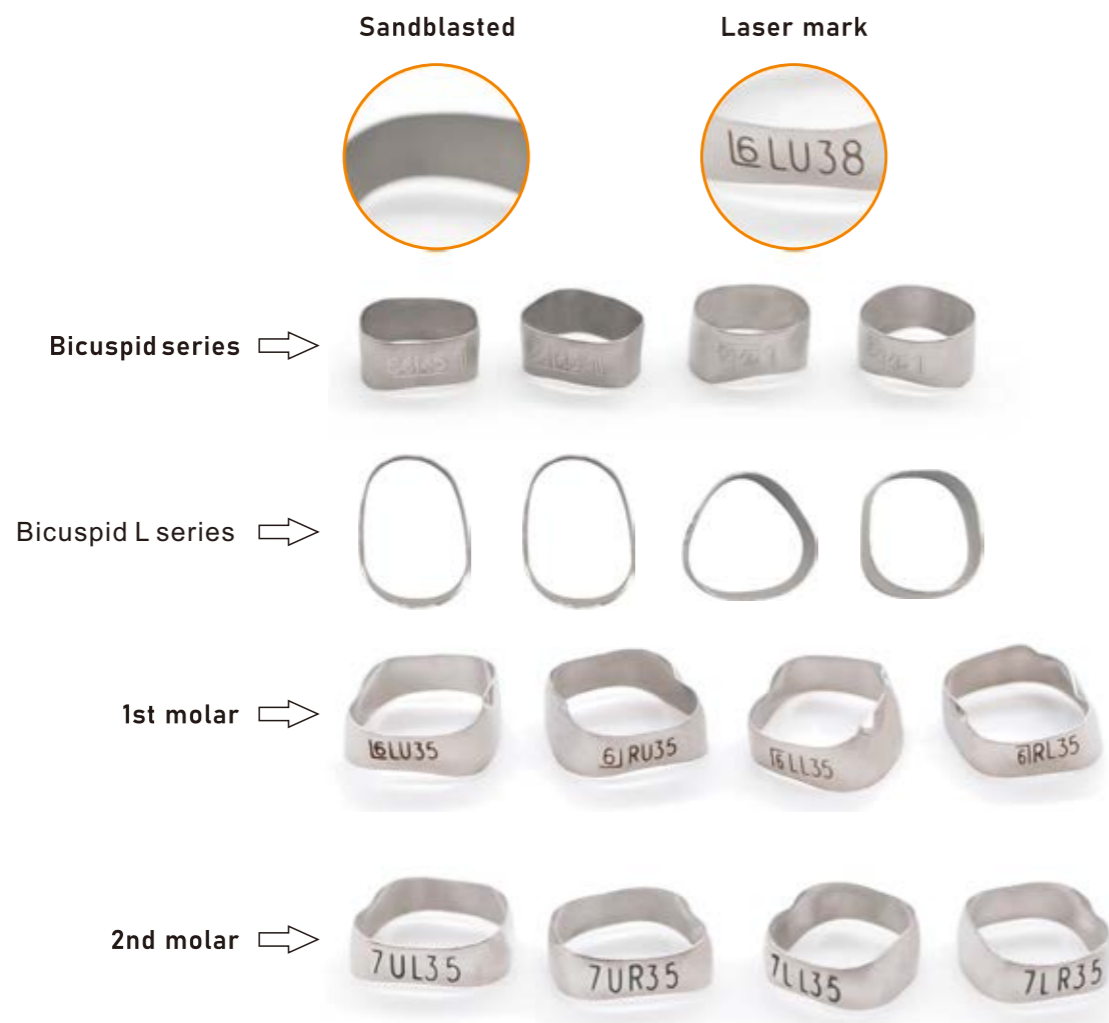

Bicuspid Plain Bands

Size		Perimeter(mm)		Item NO.	
		upper	Lower	Tooth	Tooth
				U45	L45
1	G	21	20.5	B5U-01	B5L-01
2	G+	21.6	21.1	B5U-02	B5L-02
3	H	22.2	21.6	B5U-03	B5L-03
4	H+	22.7	22.1	B5U-04	B5L-04
5	I	23.2	22.6	B5U-05	B5L-05
6	I+	23.7	23.3	B5U-06	B5L-06
7	J	24.2	24	B5U-07	B5L-07
8	J+	25	24.5	B5U-08	B5L-08
9	K	25.5	25	B5U-09	B5L-09
10	K+	26.5	26	B5U-10	B5L-10
11	L	27.5	27	B5U-11	B5L-11
12	L+	28	27.5	B5U-12	B5L-12
13	M	28.5	28	B5U-13	B5L-13
14	M+	29	28.5	B5U-14	B5L-14
15	N	29.5	29	B5U-15	B5L-15
16	N+	30	29.5	B5U-16	B5L-16



Bicuspid L Series Plain Bands

TYPE	Perimeter(mm)			Item NO.		
	Upper	Lower4	Lower5	Tooth		L5
				U45	L4	
1	21.75	19.6		B1U-0011	B1L-0011	
2	22.1	20		B1U-0021	B1L-0021	
3	22.4	20.4	20.3	B1U-0031	B1L-0031	B01-0031
4	22.7	20.8	20.8	B1U-0041	B1L-0041	B01-0041
5	23	21.2	21.3	B1U-0051	B1L-0051	B01-0051
6	23.4	21.6	21.8	B1U-0061	B1L-0061	B01-0061
7	23.8	22.1	22.2	B1U-0071	B1L-0071	B01-0071
8	24.2	22.6	22.6	B1U-0081	B1L-0081	B01-0081
9	24.6	23	23.1	B1U-0091	B1L-0091	B01-0091
10	25	23.4	23.5	B1U-0101	B1L-0101	B01-0101
11	25.4	23.8	24	B1U-0111	B1L-0111	B01-0111
12	25.8	24.3	24.4	B1U-0121	B1L-0121	B01-0121
13	26.2	24.8	24.8	B1U-0131	B1L-0131	B01-0131
14	26.6	25.2	25.2	B1U-0141	B1L-0141	B01-0141
15	27	25.6	25.7	B1U-0151	B1L-0151	B01-0151
16	27.4	26	26.1	B1U-0161	B1L-0161	B01-0161
17	27.8	26.4	26.5	B1U-0171	B1L-0171	B01-0171
18	28.2	26.8	26.9	B1U-0181	B1L-0181	B01-0181
19	28.6	27.3	27.3	B1U-0191	B1L-0191	B01-0191
20	29	27.8	27.7	B1U-0201	B1L-0201	B01-0201
21	29.4	28.2	28.1	B1U-0211	B1L-0211	B01-0211
22	29.8	28.6	28.6	B1U-0221	B1L-0221	B01-0221
23	30.2	29	29	B1U-0231	B1L-0231	B01-0231
24	30.6	29.5	29.5	B1U-0241	B1L-0241	B01-0241
25			30			B01-0251
26			30.5			B01-0261



1st Molar M Series Plain Bands

TYPE	Perimeter(mm)		Item NO.			
	upper	Lower	Tooth		Tooth	
			UR	UL	LL	LR
28	27.5	28	B6UR-280	B6UL-280	B6LL-280	B6LR-280
28+	28	28.5	B6UR-285	B6UL-285	B6LL-285	B6LR-285
29	28.5	29	B6UR-290	B6UL-290	B6LL-290	B6LR-290
29+	29	29.5	B6UR-295	B6UL-295	B6LL-295	B6LR-295
30	29.5	30	B6UR-300	B6UL-300	B6LL-300	B6LR-300
30+	30	30.5	B6UR-305	B6UL-305	B6LL-305	B6LR-305
31	30.5	31	B6UR-310	B6UL-310	B6LL-310	B6LR-310
31+	31	31.5	B6UR-315	B6UL-315	B6LL-315	B6LR-315
32	31.5	32	B6UR-320	B6UL-320	B6LL-320	B6LR-320
32+	32	32.5	B6UR-325	B6UL-325	B6LL-325	B6LR-325
33	32.5	33	B6UR-330	B6UL-330	B6LL-330	B6LR-330
33+	33	33.5	B6UR-335	B6UL-335	B6LL-335	B6LR-335
34	33.5	34	B6UR-340	B6UL-340	B6LL-340	B6LR-340
34+	34	34.5	B6UR-345	B6UL-345	B6LL-345	B6LR-345
35	34.5	35	B6UR-350	B6UL-350	B6LL-350	B6LR-350
35+	35	35.5	B6UR-355	B6UL-355	B6LL-355	B6LR-355
36	35.5	36	B6UR-360	B6UL-360	B6LL-360	B6LR-360
36+	36	36.5	B6UR-365	B6UL-365	B6LL-365	B6LR-365
37	36.5	37	B6UR-370	B6UL-370	B6LL-370	B6LR-370
37+	37	37.5	B6UR-375	B6UL-375	B6LL-375	B6LR-375
38	37.5	38	B6UR-380	B6UL-380	B6LL-380	B6LR-380
38+	38	38.5	B6UR-385	B6UL-385	B6LL-385	B6LR-385
39	38.5	39	B6UR-390	B6UL-390	B6LL-390	B6LR-390
39+	39	39.5	B6UR-395	B6UL-395	B6LL-395	B6LR-395
40	39.5	40	B6UR-400	B6UL-400	B6LL-400	B6LR-400
40+	40	40.5	B6UR-405	B6UL-405	B6LL-405	B6LR-405
41	40.5	41	B6UR-410	B6UL-410	B6LL-410	B6LR-410
41+	41	41.5	B6UR-415	B6UL-415	B6LL-415	B6LR-415
42	41.5	42	B6UR-420	B6UL-420	B6LL-420	B6LR-420
42+	42	42.5	B6UR-425	B6UL-425	B6LL-425	B6LR-425
43	42.5	43	B6UR-430	B6UL-430	B6LL-430	B6LR-430
43+	43	43.5	B6UR-435	B6UL-435	B6LL-435	B6LR-435
44	43.5	44	B6UR-440	B6UL-440	B6LL-440	B6LR-440
44+	44	44.5	B6UR-445	B6UL-445	B6LL-445	B6LR-445



1st Molar G Series Plain Bands

TYPE	Perimeter(mm)		Item NO.			
	upper	Lower	Tooth		Tooth	
			UR	UL	LL	LR
1	29.75	29.75	B9UR-01	B9UL-01	B9LL-01	B9LR-01
2	30.5	30.5	B9UR-02	B9UL-02	B9LL-02	B9LR-02
3	31.25	31.25	B9UR-03	B9UL-03	B9LL-03	B9LR-03
4	31.75	31.75	B9UR-04	B9UL-04	B9LL-04	B9LR-04
5	32.25	32.25	B9UR-05	B9UL-05	B9LL-05	B9LR-05
6	32.75	32.75	B9UR-06	B9UL-06	B9LL-06	B9LR-06
7	33.5	33.4	B9UR-07	B9UL-07	B9LL-07	B9LR-07
8	34	33.9	B9UR-08	B9UL-08	B9LL-08	B9LR-08
9	34.5	34.3	B9UR-09	B9UL-09	B9LL-09	B9LR-09
10	34.9	34.7	B9UR-10	B9UL-10	B9LL-10	B9LR-10
11	35.3	35.1	B9UR-11	B9UL-11	B9LL-11	B9LR-11
12	35.7	35.4	B9UR-12	B9UL-12	B9LL-12	B9LR-12
13	36.1	35.75	B9UR-13	B9UL-13	B9LL-13	B9LR-13
14	36.5	36.1	B9UR-14	B9UL-14	B9LL-14	B9LR-14
15	36.9	36.4	B9UR-15	B9UL-15	B9LL-15	B9LR-15
16	37.3	36.8	B9UR-16	B9UL-16	B9LL-16	B9LR-16
17	37.7	37.2	B9UR-17	B9UL-17	B9LL-17	B9LR-17
18	38.1	37.6	B9UR-18	B9UL-18	B9LL-18	B9LR-18
19	38.4	38	B9UR-19	B9UL-19	B9LL-19	B9LR-19
20	38.7	38.4	B9UR-20	B9UL-20	B9LL-20	B9LR-20
21	39.1	38.8	B9UR-21	B9UL-21	B9LL-21	B9LR-21
22	39.5	39.2	B9UR-22	B9UL-22	B9LL-22	B9LR-22
23	39.9	39.6	B9UR-23	B9UL-23	B9LL-23	B9LR-23
24	40.3	40	B9UR-24	B9UL-24	B9LL-24	B9LR-24
25	40.7	40.4	B9UR-25	B9UL-25	B9LL-25	B9LR-25
26	41.1	40.8	B9UR-26	B9UL-26	B9LL-26	B9LR-26
27	41.5	41.2	B9UR-27	B9UL-27	B9LL-27	B9LR-27
28	41.9	41.75	B9UR-28	B9UL-28	B9LL-28	B9LR-28
29	42.3	42.5	B9UR-29	B9UL-29	B9LL-29	B9LR-29
30	42.7	43.25	B9UR-30	B9UL-30	B9LL-30	B9LR-30
31	43.1	44	B9UR-31	B9UL-31	B9LL-31	B9LR-31
32	43.5	44.5	B9UR-32	B9UL-32	B9LL-32	B9LR-32



2nd Molar M Series Plain Bands

TYPE	Perimeter(mm)		Item NO.			
	upper	Lower	Tooth		Tooth	
			UR	UL	LL	LR
28	28.8	29	B7UR-280	B7UL-280	B7LL-280	B7LR-280
28+	29.3	29.5	B7UR-285	B7UL-285	B7LL-285	B7LR-285
29	29.8	30	B7UR-290	B7UL-290	B7LL-290	B7LR-290
29+	30.3	30.5	B7UR-295	B7UL-295	B7LL-295	B7LR-295
30	30.8	31.5	B7UR-300	B7UL-300	B7LL-300	B7LR-300
30+	31.3	31.9	B7UR-305	B7UL-305	B7LL-305	B7LR-305
31	31.8	32.3	B7UR-310	B7UL-310	B7LL-310	B7LR-310
31+	32.2	32.6	B7UR-315	B7UL-315	B7LL-315	B7LR-315
32	32.6	33.4	B7UR-320	B7UL-320	B7LL-320	B7LR-320
32+	33	33.8	B7UR-325	B7UL-325	B7LL-325	B7LR-325
33	33.4	34.2	B7UR-330	B7UL-330	B7LL-330	B7LR-330
33+	33.8	34.6	B7UR-335	B7UL-335	B7LL-335	B7LR-335
34	34.6	35.4	B7UR-340	B7UL-340	B7LL-340	B7LR-340
34+	35	35.8	B7UR-345	B7UL-345	B7LL-345	B7LR-345
35	35.4	36.2	B7UR-350	B7UL-350	B7LL-350	B7LR-350
35+	35.8	36.5	B7UR-355	B7UL-355	B7LL-355	B7LR-355
36	36.2	37	B7UR-360	B7UL-360	B7LL-360	B7LR-360
36+	37	37.4	B7UR-365	B7UL-365	B7LL-365	B7LR-365
37	37.8	38.2	B7UR-370	B7UL-370	B7LL-370	B7LR-370
37+	38.6	38.6	B7UR-375	B7UL-375	B7LL-375	B7LR-375
38	39	39	B7UR-380	B7UL-380	B7LL-380	B7LR-380
38+	39.4	39.35	B7UR-385	B7UL-385	B7LL-385	B7LR-385
39	39.8	39.7	B7UR-390	B7UL-390	B7LL-390	B7LR-390
39+	40.2	40	B7UR-395	B7UL-395	B7LL-395	B7LR-395
40	41	40.5	B7UR-400	B7UL-400	B7LL-400	B7LR-400
40+	41.5	41	B7UR-405	B7UL-405	B7LL-405	B7LR-405
41	42	41.5	B7UR-410	B7UL-410	B7LL-410	B7LR-410
41+	42.5	42	B7UR-415	B7UL-415	B7LL-415	B7LR-415
42	43	42.5	B7UR-420	B7UL-420	B7LL-420	B7LR-420
42+	43.5	43	B7UR-425	B7UL-425	B7LL-425	B7LR-425
43	44	43.5	B7UR-430	B7UL-430	B7LL-430	B7LR-430
43+	44.5	44	B7UR-435	B7UL-435	B7LL-435	B7LR-435
44	45	44.5	B7UR-440	B7UL-440	B7LL-440	B7LR-440



2nd Molar G Series Plain Bands

TYPE	Perimeter(mm)		Item NO.			
	upper	Lower	Tooth		Tooth	
			UR	UL	LL	LR
1	28.8	28.5	B7UR-0011	B7UL-0011	B7LL-0011	B7LR-0011
2	29.3	29	B7UR-0021	B7UL-0021	B7LL-0021	B7LR-0021
3	29.8	29.5	B7UR-0031	B7UL-0031	B7LL-0031	B7LR-0031
4	30.3	30	B7UR-0041	B7UL-0041	B7LL-0041	B7LR-0041
5	30.8	30.5	B7UR-0051	B7UL-0051	B7LL-0051	B7LR-0051
6	31.3	31	B7UR-0061	B7UL-0061	B7LL-0061	B7LR-0061
7	31.8	31.5	B7UR-0071	B7UL-0071	B7LL-0071	B7LR-0071
8	32.2	31.9	B7UR-0081	B7UL-0081	B7LL-0081	B7LR-0081
9	32.6	32.3	B7UR-0091	B7UL-0091	B7LL-0091	B7LR-0091
10	33	32.6	B7UR-0101	B7UL-0101	B7LL-0101	B7LR-0101
11	33.4	33	B7UR-0111	B7UL-0111	B7LL-0111	B7LR-0111
12	33.8	33.4	B7UR-0121	B7UL-0121	B7LL-0121	B7LR-0121
13	34.2	33.8	B7UR-0131	B7UL-0131	B7LL-0131	B7LR-0131
14	34.6	34.2	B7UR-0141	B7UL-0141	B7LL-0141	B7LR-0141
15	35	34.6	B7UR-0151	B7UL-0151	B7LL-0151	B7LR-0151
16	35.4	35	B7UR-0161	B7UL-0161	B7LL-0161	B7LR-0161
17	35.8	35.4	B7UR-0171	B7UL-0171	B7LL-0171	B7LR-0171
18	36.2	35.8	B7UR-0181	B7UL-0181	B7LL-0181	B7LR-0181
19	37	36.2	B7UR-0191	B7UL-0191	B7LL-0191	B7LR-0191
20	37.4	36.5	B7UR-0201	B7UL-0201	B7LL-0201	B7LR-0201
21	37.8	37	B7UR-0211	B7UL-0211	B7LL-0211	B7LR-0211
22	38.2	37.4	B7UR-0221	B7UL-0221	B7LL-0221	B7LR-0221
23	38.6	37.8	B7UR-0231	B7UL-0231	B7LL-0231	B7LR-0231
24	39	38.2	B7UR-0241	B7UL-0241	B7LL-0241	B7LR-0241
25	39.4	38.6	B7UR-0251	B7UL-0251	B7LL-0251	B7LR-0251
26	39.8	39	B7UR-0261	B7UL-0261	B7LL-0261	B7LR-0261
27	40.2	39.35	B7UR-0271	B7UL-0271	B7LL-0271	B7LR-0271
28	40.6	39.7	B7UR-0281	B7UL-0281	B7LL-0281	B7LR-0281
29	41	40	B7UR-0291	B7UL-0291	B7LL-0291	B7LR-0291
30	41.5	40.5	B7UR-0301	B7UL-0301	B7LL-0301	B7LR-0301

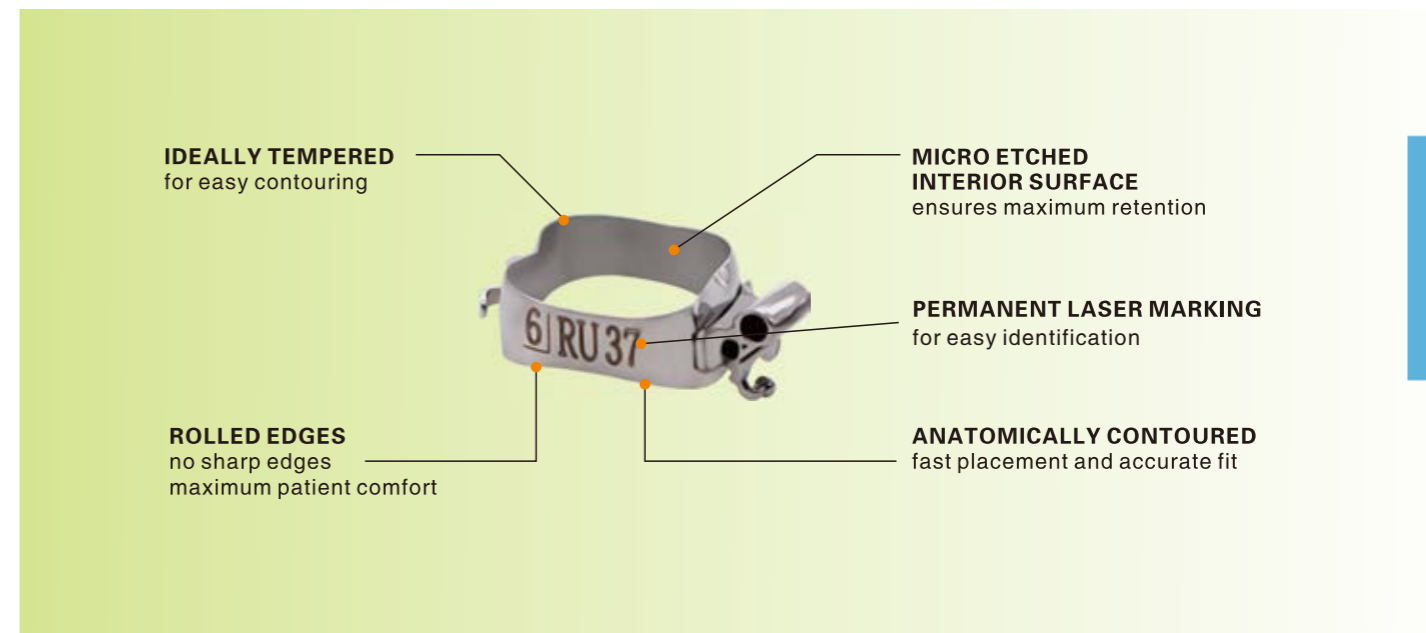

Maxillary



Occlusal gingiva positioning
Center of edgewise slot nearest occlusal is 0.075in(1.9mm)



Centerline of buccal tube positioned on buccal indent
From occlusal edge of band Round tube mounted to occlusal

Mandibular



Occlusal gingiva positioning
center of edgewise slot nearest occlusal is 0.075in.(1.9mm)
from occlusal edge of band.hooks are located in mesial-gingival coordinate.

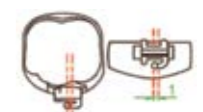

Mesial distal positioning
centerline of buccal tube positioned 0.040in. (1.0mm distal from mesial buccal indent.)

Lingual Optional



Buccal Optional





Bicuspid Bands Pre-welded With Brackets

SYSTEM	Teeth	Torque	Offset	Width	Item NO.			
					no hook		with hook	
					.018	.022	.018	.022
Roth	UR	-7°	0°	3.1	D552-31UR-SS	D552-32UR-SS	D552-21UR-SS	D552-22UR-SS
	UL	-7°	0°	3.1	D552-31UL-SS	D552-32UL-SS	D552-21UL-SS	D552-22UL-SS
	LL	-17°	0°	3.1	D552-31LL-SS	D552-32LL-SS	D552-21LL-SS	D552-22LL-SS
	LR	-17°	0°	3.1	D552-31LR-SS	D552-32LR-SS	D552-21LR-SS	D552-22LR-SS
MBT	UR	-7°	0°	3.1	D553-31UR-SS	D553-32UR-SS	D553-21UR-SS	D553-22UR-SS
	UL	-7°	0°	3.1	D553-31UL-SS	D553-32UL-SS	D553-21UL-SS	D553-22UL-SS
	LL	-12°	0°	3.1	D553-31LL-SS	D553-32LL-SS	D553-21LL-SS	D553-22LL-SS
	LR	-12°	0°	3.1	D553-31LR-SS	D553-32LR-SS	D553-21LR-SS	D553-22LR-SS
Edgewise	UR	0°	0°	3.1	D551-31UR-SS	D551-32UR-SS	D551-21UR-SS	D551-22UR-SS
	UL	0°	0°	3.1	D551-31UL-SS	D551-32UL-SS	D551-21UL-SS	D551-22UL-SS
	LL	0°	0°	3.1	D551-31LL-SS	D551-32LL-SS	D551-21LL-SS	D551-22LL-SS
	LR	0°	0°	3.1	D551-31LR-SS	D551-32LR-SS	D551-21LR-SS	D551-22LR-SS

Full Set: 4pcs/set

SYSTEM	Teeth	Torque	Offset	Width	Item NO.			
					no hook		with hook	
					.018	.022	.018	.022
Roth	Upper	-7°	0°	3.1	D552-31-SS	D552-32-SS	D552-21-SS	D552-22-SS
	Lower	-17°	0°	3.1				
MBT	Upper	-7°	0°	3.1	D553-31-SS	D553-32-SS	D553-21-SS	D553-22-SS
	Lower	-12°	0°	3.1				
Edgewise	Upper	0°	0°	3.1	D551-31-SS	D551-32-SS	D551-21-SS	D551-22-SS
	Lower	0°	0°	3.1				

SS stands for band size



Bicuspid L Series Bands Pre-welded With Brackets

SYSTEM	Teeth	Torque	Offset	Width	Item NO.			
					no hook		with hook	
					.018	.022	.018	.022
Roth	UR	-7°	0°	3.1	D152-31UR-SS	D152-32UR-SS	D152-21UR-SS	D152-22UR-SS
	UL	-7°	0°	3.1	D152-31UL-SS	D152-32UL-SS	D152-21UL-SS	D152-22UL-SS
	LL	-17°	0°	3.1	D152-31LL-SS	D152-32LL-SS	D152-21LL-SS	D152-22LL-SS
	LR	-17°	0°	3.1	D152-31LR-SS	D152-32LR-SS	D152-21LR-SS	D152-22LR-SS
MBT	UR	-7°	0°	3.1	D153-31UR-SS	D153-32UR-SS	D153-21UR-SS	D153-22UR-SS
	UL	-7°	0°	3.1	D153-31UL-SS	D153-32UL-SS	D153-21UL-SS	D153-22UL-SS
	LL	-12°	0°	3.1	D153-31LL-SS	D153-32LL-SS	D153-21LL-SS	D153-22LL-SS
	LR	-12°	0°	3.1	D153-31LR-SS	D153-32LR-SS	D153-21LR-SS	D153-22LR-SS
Edgewise	UR	0°	0°	3.1	D151-31UR-SS	D151-32UR-SS	D151-21UR-SS	D151-22UR-SS
	UL	0°	0°	3.1	D151-31UL-SS	D151-32UL-SS	D151-21UL-SS	D151-22UL-SS
	LL	0°	0°	3.1	D151-31LL-SS	D151-32LL-SS	D151-21LL-SS	D151-22LL-SS
	LR	0°	0°	3.1	D151-31LR-SS	D151-32LR-SS	D151-21LR-SS	D151-22LR-SS

Full Set: 4pcs/set

SYSTEM	Teeth	Torque	Offset	Width	Item NO.			
					no hook		with hook	
					.018	.022	.018	.022
Roth	Upper	-7°	0°	3.1	D152-31-SS	D152-32-SS	D152-21-SS	D152-22-SS
	Lower	-17°	0°	3.1				
MBT	Upper	-7°	0°	3.1	D153-31-SS	D153-32-SS	D153-21-SS	D153-22-SS
	Lower	-12°	0°	3.1				
Edgewise	Upper	0°	0°	3.1	D151-31-SS	D151-32-SS	D151-21-SS	D151-22-SS
	Lower	0°	0°	3.1				

SS stands for band size



1st Molar M Series Bands Pre-welded With Tubes

Pre-welded With Single Tubes



SYSTEM	Teeth	Torque	Offset	Width	Item NO.			
					Conv		N-Conv	
					.018	.022	.018	.022
Roth	UR	-14°	10°	4	D612-11UR-SS	D612-12UR-SS	D612-01UR-SS	D612-02UR-SS
	UL	-14°	10°	4	D612-11UL-SS	D612-12UL-SS	D612-01UL-SS	D612-02UL-SS
	LL	-25°	4°	4	D612-11LL-SS	D612-12LL-SS	D612-01LL-SS	D612-02LL-SS
	LR	-25°	4°	4	D612-11LR-SS	D612-12LR-SS	D612-01LR-SS	D612-02LR-SS
MBT	UR	-14°	10°	4	D613-11UR-SS	D613-12UR-SS	D613-01UR-SS	D613-02UR-SS
	UL	-14°	10°	4	D613-11UL-SS	D613-12UL-SS	D613-01UL-SS	D613-02UL-SS
	LL	-20°	0°	4	D613-11LL-SS	D613-12LL-SS	D613-01LL-SS	D613-02LL-SS
	LR	-20°	0°	4	D613-11LR-SS	D613-12LR-SS	D613-01LR-SS	D613-02LR-SS
Edgewise	UR	0°	6°	4	D611-11UR-SS	D611-12UR-SS	D611-01UR-SS	D611-02UR-SS
	UL	0°	6°	4	D611-11UL-SS	D611-12UL-SS	D611-01UL-SS	D611-02UL-SS
	LL	0°	6°	4	D611-11LL-SS	D611-12LL-SS	D611-01LL-SS	D611-02LL-SS
	LR	0°	6°	4	D611-11LR-SS	D611-12LR-SS	D611-01LR-SS	D611-02LR-SS

Full Set: 4pcs/set



SYSTEM	Teeth	Torque	Offset	Width	Item NO.			
					Conv		N-Conv	
					.018	.022	.018	.022
Roth	Upper	-14°	10°	4	D612-11-SS	D612-12-SS	D612-01-SS	D612-02-SS
	Lower	-25°	4°	4				
MBT	Upper	-14°	10°	4	D613-11-SS	D613-12-SS	D613-01-SS	D613-02-SS
	Lower	-20°	0°	4				
Edgewise	Upper	0°	6°	4	D611-11-SS	D611-12-SS	D611-01-SS	D611-02-SS
	Lower	0°	6°	4				

SS stands for band size



1st Molar M Series Bands Pre-welded With Tubes

Pre-welded With Double Combination Tubes



SYSTEM	Teeth	Torque	Offset	Width	Item NO.			
					Conv		N-Conv	
					.018	.022	.018	.022
Roth	UR	-14°	10°	4	D622-11UR-SS	D622-12UR-SS	D622-01UR-SS	D622-02UR-SS
	UL	-14°	10°	4	D622-11UL-SS	D622-12UL-SS	D622-01UL-SS	D622-02UL-SS
MBT	UR	-14°	10°	4	D623-11UR-SS	D623-12UR-SS	D623-01UR-SS	D623-02UR-SS
	UL	-14°	10°	4	D623-11UL-SS	D623-12UL-SS	D623-01UL-SS	D623-02UL-SS
Edgewise	UR	0°	6°	4	D621-11UR-SS	D621-12UR-SS	D621-01UR-SS	D621-02UR-SS
	UL	0°	6°	4	D621-11UL-SS	D621-12UL-SS	D621-01UL-SS	D621-02UL-SS

Full Set: 4pcs/set



SYSTEM	Teeth	Torque	Offset	Width	Item NO.			
					Conv		N-Conv	
					.018	.022	.018	.022
Roth	Upper	-14°	10°	4	D622-11-SS	D622-12-SS	D622-01-SS	D622-02-SS
	Lower	-25°	4°	4				
MBT	Upper	-14°	10°	4	D623-11-SS	D623-12-SS	D623-01-SS	D623-02-SS
	Lower	-20°	0°	4				
Edgewise	Upper	0°	6°	4	D621-11-SS	D621-12-SS	D621-01-SS	D621-02-SS
	Lower	0°	6°	4				

SS stands for band size



1st Molar M Series Bands Pre-welded With Tubes

Pre-welded With Double Rectangular Tubes □□/□□



SYSTEM	Teeth	Torque	Offset	Width	Item NO.	
					Conv	
					.018	.022
Roth	UR	-14°	10°	4	D642-11UR-SS	D642-12UR-SS
	UL	-14°	10°	4	D642-11UL-SS	D642-12UL-SS
	LL	-25°	4°	4	D642-11LL-SS	D642-12LL-SS
	LR	-25°	4°	4	D642-11LR-SS	D642-12LR-SS
MBT	UR	-14°	10°	4	D643-11UR-SS	D643-12UR-SS
	UL	-14°	10°	4	D643-11UL-SS	D643-12UL-SS
	LL	-20°	0°	4	D643-11LL-SS	D643-12LL-SS
	LR	-20°	0°	4	D643-11LR-SS	D643-12LR-SS
Edgewise	UR	0°	6°	4	D641-11UR-SS	D641-12UR-SS
	UL	0°	6°	4	D641-11UL-SS	D641-12UL-SS
	LL	0°	6°	4	D641-11LL-SS	D641-12LL-SS
	LR	0°	6°	4	D641-11LR-SS	D641-12LR-SS

Full Set: 4pcs/set



SYSTEM	Teeth	Torque	Offset	Width	Item NO.	
					Conv	
					.018	.022
Roth	Upper	-14°	10°	4	D642-11-SS	D642-12-SS
	Lower	-25°	4°	4		
MBT	Upper	-14°	10°	4	D643-11-SS	D643-12-SS
	Lower	-20°	0°	4		
Edgewise	Upper	0°	6°	4	D641-11-SS	D641-12-SS
	Lower	0°	6°	4		

SS stands for band size



1st Molar M Series Bands Pre-welded With Tubes

Pre-welded With Triple Tubes □□°/□□



SYSTEM	Teeth	Torque	Offset	Width	Item NO.	
					Conv	
					.018	.022
Roth	UR	-14°	10°	4	D632-11UR-SS	D632-12UR-SS
	UL	-14°	10°	4	D632-11UL-SS	D632-12UL-SS
MBT	UR	-14°	10°	4	D633-11UR-SS	D633-12UR-SS
	UL	-14°	10°	4	D633-11UL-SS	D633-12UL-SS
Edgewise	UR	0°	6°	4	D631-11UR-SS	D631-12UR-SS
	UL	0°	6°	4	D631-11UL-SS	D631-12UL-SS

Full Set: 4pcs/set



SYSTEM	Teeth	Torque	Offset	Width	Item NO.	
					Conv	
					.018	.022
Roth	Upper	-14°	10°	4	D632-11-SS	D632-12-SS
	Lower	-25°	4°	4		
MBT	Upper	-14°	10°	4	D633-11-SS	D633-12-SS
	Lower	-20°	0°	4		
Edgewise	Upper	0°	6°	4	D631-11-SS	D631-12-SS
	Lower	0°	6°	4		

SS stands for band size



1st Molar G Series Bands Pre-welded With Tubes

Pre-welded With Single Tubes



SYSTEM	Teeth	Torque	Offset	Width	Item NO.			
					Conv		N-Conv	
					.018	.022	.018	.022
Roth	UR	-14°	10°	4	D912-11UR-SS	D912-12UR-SS	D912-01UR-SS	D912-02UR-SS
	UL	-14°	10°	4	D912-11UL-SS	D912-12UL-SS	D912-01UL-SS	D912-02UL-SS
	LL	-25°	4°	4	D912-11LL-SS	D912-12LL-SS	D912-01LL-SS	D912-02LL-SS
	LR	-25°	4°	4	D912-11LR-SS	D912-12LR-SS	D912-01LR-SS	D912-02LR-SS
MBT	UR	-14°	10°	4	D913-11UR-SS	D913-12UR-SS	D913-01UR-SS	D913-02UR-SS
	UL	-14°	10°	4	D913-11UL-SS	D913-12UL-SS	D913-01UL-SS	D913-02UL-SS
	LL	-20°	0°	4	D913-11LL-SS	D913-12LL-SS	D913-01LL-SS	D913-02LL-SS
	LR	-20°	0°	4	D913-11LR-SS	D913-12LR-SS	D913-01LR-SS	D913-02LR-SS
Edgewise	UR	0°	6°	4	D911-11UR-SS	D911-12UR-SS	D911-01UR-SS	D911-02UR-SS
	UL	0°	6°	4	D911-11UL-SS	D911-12UL-SS	D911-01UL-SS	D911-02UL-SS
	LL	0°	6°	4	D911-11LL-SS	D911-12LL-SS	D911-01LL-SS	D911-02LL-SS
	LR	0°	6°	4	D911-11LR-SS	D911-12LR-SS	D911-01LR-SS	D911-02LR-SS

Full Set: 4pcs/set



SYSTEM	Teeth	Torque	Offset	Width	Item NO.			
					Conv		N-Conv	
					.018	.022	.018	.022
Roth	Upper	-14°	10°	4	D912-11-SS	D912-12-SS	D912-01-SS	D912-02-SS
	Lower	-25°	4°	4				
MBT	Upper	-14°	10°	4	D913-11-SS	D913-12-SS	D913-01-SS	D913-02-SS
	Lower	-20°	0°	4				
Edgewise	Upper	0°	6°	4	D911-11-SS	D911-12-SS	D911-01-SS	D911-02-SS
	Lower	0°	6°	4				

SS stands for band size



1st Molar G Series Bands Pre-welded With Tubes

Pre-welded With Double Combination Tubes



SYSTEM	Teeth	Torque	Offset	Width	Item NO.			
					Conv		N-Conv	
					.018	.022	.018	.022
Roth	UR	-14°	10°	4	D922-11UR-SS	D922-12UR-SS	D922-01UR-SS	D922-02UR-SS
	UL	-14°	10°	4	D922-11UL-SS	D922-12UL-SS	D922-01UL-SS	D922-02UL-SS
MBT	UR	-14°	10°	4	D923-11UR-SS	D923-12UR-SS	D923-01UR-SS	D923-02UR-SS
	UL	-14°	10°	4	D923-11UL-SS	D923-12UL-SS	D923-01UL-SS	D923-02UL-SS
Edgewise	UR	0°	6°	4	D921-11UR-SS	D921-12UR-SS	D921-01UR-SS	D921-02UR-SS
	UL	0°	6°	4	D921-11UL-SS	D921-12UL-SS	D921-01UL-SS	D921-02UL-SS

Full Set: 4pcs/set



SYSTEM	Teeth	Torque	Offset	Width	Item NO.			
					Conv		N-Conv	
					.018	.022	.018	.022
Roth	Upper	-14°	10°	4	D922-11-SS	D922-12-SS	D922-01-SS	D922-02-SS
	Lower	-25°	4°	4				
MBT	Upper	-14°	10°	4	D923-11-SS	D923-12-SS	D923-01-SS	D923-02-SS
	Lower	-20°	0°	4				
Edgewise	Upper	0°	6°	4	D921-11-SS	D921-12-SS	D921-01-SS	D921-02-SS
	Lower	0°	6°	4				

SS stands for band size



1st Molar G Series Bands Pre-welded With Tubes

Pre-welded With Double Rectangular Tubes □□/□□



SYSTEM	Teeth	Torque	Offset	Width	Item NO.	
					Conv	
					.018	.022
Roth	UR	-14°	10°	4	D942-11UR-SS	D942-12UR-SS
	UL	-14°	10°	4	D942-11UL-SS	D942-12UL-SS
	LL	-25°	4°	4	D942-11LL-SS	D942-12LL-SS
	LR	-25°	4°	4	D942-11LR-SS	D942-12LR-SS
MBT	UR	-14°	10°	4	D943-11UR-SS	D943-12UR-SS
	UL	-14°	10°	4	D943-11UL-SS	D943-12UL-SS
	LL	-20°	0°	4	D943-11LL-SS	D943-12LL-SS
	LR	-20°	0°	4	D943-11LR-SS	D943-12LR-SS
Edgewise	UR	0°	6°	4	D941-11UR-SS	D941-12UR-SS
	UL	0°	6°	4	D941-11UL-SS	D941-12UL-SS
	LL	0°	6°	4	D941-11LL-SS	D941-12LL-SS
	LR	0°	6°	4	D941-11LR-SS	D941-12LR-SS



Full Set: 4pcs/set

SYSTEM	Teeth	Torque	Offset	Width	Item NO.	
					Conv	
					.018	.022
Roth	Upper	-14°	10°	4	D942-11-SS	D942-12-SS
	Lower	-25°	4°	4		
MBT	Upper	-14°	10°	4	D943-11-SS	D943-12-SS
	Lower	-20°	0°	4		
Edgewise	Upper	0°	6°	4	D941-11-SS	D941-12-SS
	Lower	0°	6°	4		

SS stands for band size



1st Molar G Series Bands Pre-welded With Tubes

Pre-welded With Triple Tubes □□○/□□



SYSTEM	Teeth	Torque	Offset	Width	Item NO.	
					Conv	
					.018	.022
Roth	UR	-14°	10°	4	D932-11UR-SS	D932-12UR-SS
	UL	-14°	10°	4	D932-11UL-SS	D932-12UL-SS
MBT	UR	-14°	10°	4	D933-11UR-SS	D933-12UR-SS
	UL	-14°	10°	4	D933-11UL-SS	D933-12UL-SS
Edgewise	UR	0°	6°	4	D931-11UR-SS	D931-12UR-SS
	UL	0°	6°	4	D931-11UL-SS	D931-12UL-SS



Full Set: 4pcs/set

SYSTEM	Teeth	Torque	Offset	Width	Item NO.	
					Conv	
					.018	.022
Roth	Upper	-14°	10°	4	D932-11-SS	D932-12-SS
	Lower	-25°	4°	4		
MBT	Upper	-14°	10°	4	D933-11-SS	D933-12-SS
	Lower	-20°	0°	4		
Edgewise	Upper	0°	6°	4	D931-11-SS	D931-12-SS
	Lower	0°	6°	4		

SS stands for band size



2nd Molar M Series Bands Pre-welded With Tubes

Pre-welded With Single Tubes



SYSTEM	Teeth	Torque	Offset	Width	Item NO.	
					N-Conv	
					.018	.022
Roth	UR	-14°	10°	3.2	D812-01UR-SS	D812-02UR-SS
	UL	-14°	10°	3.2	D812-01UL-SS	D812-02UL-SS
	LL	-25°	4°	3.2	D812-01LL-SS	D812-02LL-SS
	LR	-25°	4°	3.2	D812-01LR-SS	D812-02LR-SS
MBT	UR	-14°	10°	3.2	D813-01UR-SS	D813-02UR-SS
	UL	-14°	10°	3.2	D813-01UL-SS	D813-02UL-SS
	LL	-10°	0°	3.2	D813-01LL-SS	D813-02LL-SS
	LR	-10°	0°	3.2	D813-01LR-SS	D813-02LR-SS
Edgewise	UR	0°	6°	3.2	D811-01UR-SS	D811-02UR-SS
	UL	0°	6°	3.2	D811-01UL-SS	D811-02UL-SS
	LL	0°	6°	3.2	D811-01LL-SS	D811-02LL-SS
	LR	0°	6°	3.2	D811-01LR-SS	D811-02LR-SS



Full Set: 4pcs/set

SYSTEM	Teeth	Torque	Offset	Width	Item NO.	
					N-Conv	
					.018	.022
Roth	Upper	-14°	10°	3.2	D812-01-SS	D812-02-SS
	Lower	-25°	4°	3.2		
MBT	Upper	-14°	10°	3.2	D813-01-SS	D813-02-SS
	Lower	-10°	0°	3.2		
Edgewise	Upper	0°	6°	3.2	D811-01-SS	D811-02-SS
	Lower	0°	6°	3.2		

SS stands for band size



2nd Molar G Series Bands Pre-welded With Tubes

Pre-welded With Single Tubes



SYSTEM	Teeth	Torque	Offset	Width	Item NO.	
					N-Conv	
					.018	.022
Roth	UR	-14°	10°	3.2	D712-01UR-SS	D712-02UR-SS
	UL	-14°	10°	3.2	D712-01UL-SS	D712-02UL-SS
	LL	-25°	4°	3.2	D712-01LL-SS	D712-02LL-SS
	LR	-25°	4°	3.2	D712-01LR-SS	D712-02LR-SS
MBT	UR	-14°	10°	3.2	D713-01UR-SS	D713-02UR-SS
	UL	-14°	10°	3.2	D713-01UL-SS	D713-02UL-SS
	LL	-10°	0°	3.2	D713-01LL-SS	D713-02LL-SS
	LR	-10°	0°	3.2	D713-01LR-SS	D713-02LR-SS
Edgewise	UR	0°	6°	3.2	D711-01UR-SS	D711-02UR-SS
	UL	0°	6°	3.2	D711-01UL-SS	D711-02UL-SS
	LL	0°	6°	3.2	D711-01LL-SS	D711-02LL-SS
	LR	0°	6°	3.2	D711-01LR-SS	D711-02LR-SS



Full Set: 4pcs/set

SYSTEM	Teeth	Torque	Offset	Width	Item NO.	
					N-Conv	
					.018	.022
Roth	Upper	-14°	10°	3.2	D712-01-SS	D712-02-SS
	Lower	-25°	4°	3.2		
MBT	Upper	-14°	10°	3.2	D713-01-SS	D713-02-SS
	Lower	-10°	0°	3.2		
Edgewise	Upper	0°	6°	3.2	D711-01-SS	D711-02-SS
	Lower	0°	6°	3.2		

SS stands for band size



Prewelded Bands Coding Rule

D 6	1	2	1	1	UR	3 1 5	1
D5: bicuspid bands D1: bicuspid L series bands D6: 1st molar M series bands D9: 1st molar G series bands D8: 2nd molar M series bands D7: 2nd molar G series bands	1: single buccal 2: double combination 3: triple buccal 4: double rectangular 5: bracket	1: Edgewise 2: Roth 3: MBT	0: N-conv 1: Conv 2: with hook 3: no hook	1: 0.018" 2: 0.022"	UR: upper right UL: upper left LR: lower right LL: lower left	band size: 31+	1: lingual sheath without hook 2: lingual sheath with hook 3: lingual button 4: lingual cleat big 5: lingual cleat small 6: seating lug

M Series band G1 Package matching table

band size	28	28+	29	29+	30	30+	31	31+	32	32+	33	33+	34	34+	35	35+	36	36+	37	37+	38	38+	39	39+	40	40+	41	41+	42	42+	43	43+	44
85 SET	1	1	1	1	1	1	2	2	2	2	2	2	4	4	5	5	5	5	5	5	5	5	4	4	2	2	1	1	1	1	1	1	1

M Series band G3 Package matching table

Default size #34.5-#39, or you can choose any 20 sets

band size	28	28+	29	29+	30	30+	31	31+	32	32+	33	33+	34	34+	35	35+	36	36+	37	37+	38	38+	39	39+	40	40+	41	41+	42	42+	43	43+	44
20 SET	0	0	0	0	0	0	0	0	0	0	0	0	2	2	2	2	2	2	2	2	2	2	2	0	0	0	0	0	0	0	0	0	

M Series Bands

(Regular choice)

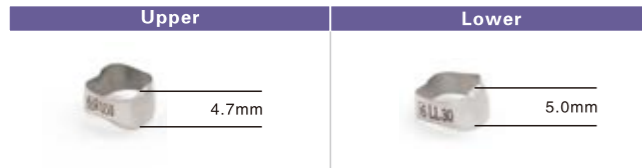

Extra-thin M Series Bands

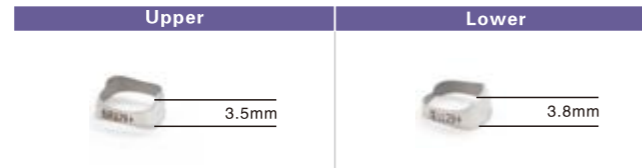

G Series band G1 Package matching table

band size	1	2	3	4	5	6	7	8	9	10	11	12	13	14	15	16	17	18	19	20	21	22	23	24	25	26	27	28	29	30	31	32
85 SET	1	1	1	1	1	1	2	2	2	2	2	2	4	5	5	5	5	5	5	5	5	5	4	4	2	2	1	1	1	1	1	1

G Series band G3 Package matching table

Default size #13-#22, or you can choose any 20sets

band size	1	2	3	4	5	6	7	8	9	10	11	12	13	14	15	16	17	18	19	20	21	22	23	24	25	26	27	28	29	30	31	32
20 SET	0	0	0	0	0	0	0	0	0	0	0	0	2	2	2	2	2	2	2	2	2	2	0	0	0	0	0	0	0	0	0	0

G Series Bands

(Regular choice)

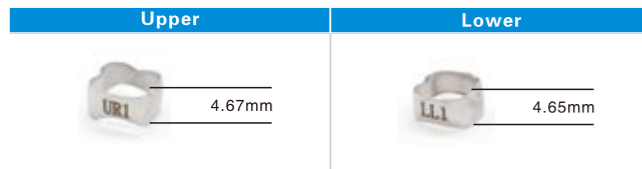

Extra-thin G Series Bands

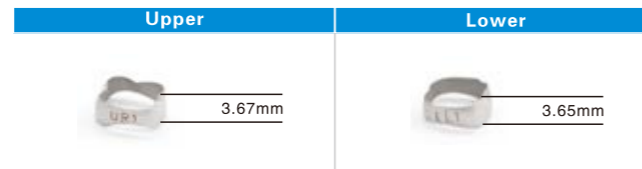

1st Molar M Series

TYPE	Perimeter(mm)		Item NO.				Set
			Tooth		Tooth		
	upper	Lower	UR	UL	LL	LR	
28	28.8	29	M1UR-280	M1UL-280	M1LL-280	M1LR-280	M111-28
28+	29.3	29.5	M1UR-285	M1UL-285	M1LL-285	M1LR-285	M111-28+
29	29.8	30	M1UR-290	M1UL-290	M1LL-290	M1LR-290	M111-29
29+	30.3	30.5	M1UR-295	M1UL-295	M1LL-295	M1LR-295	M111-29+
30	30.8	31.5	M1UR-300	M1UL-300	M1LL-300	M1LR-300	M111-30
30+	31.3	31.9	M1UR-305	M1UL-305	M1LL-305	M1LR-305	M111-30+
31	31.8	32.3	M1UR-310	M1UL-310	M1LL-310	M1LR-310	M111-31
31+	32.2	32.6	M1UR-315	M1UL-315	M1LL-315	M1LR-315	M111-31+
32	32.6	33.4	M1UR-320	M1UL-320	M1LL-320	M1LR-320	M111-32
32+	33	33.8	M1UR-325	M1UL-325	M1LL-325	M1LR-325	M111-32+
33	33.4	34.2	M1UR-330	M1UL-330	M1LL-330	M1LR-330	M111-33
33+	33.8	34.6	M1UR-335	M1UL-335	M1LL-335	M1LR-335	M111-33+
34	34.6	35.4	M1UR-340	M1UL-340	M1LL-340	M1LR-340	M111-34
34+	35	35.8	M1UR-345	M1UL-345	M1LL-345	M1LR-345	M111-34+
35	35.4	36.2	M1UR-350	M1UL-350	M1LL-350	M1LR-350	M111-35
35+	35.8	36.5	M1UR-355	M1UL-355	M1LL-355	M1LR-355	M111-35+
36	36.2	37	M1UR-360	M1UL-360	M1LL-360	M1LR-360	M111-36
36+	37	37.4	M1UR-365	M1UL-365	M1LL-365	M1LR-365	M111-36+
37	37.8	38.2	M1UR-370	M1UL-370	M1LL-370	M1LR-370	M111-37
37+	38.6	38.6	M1UR-375	M1UL-375	M1LL-375	M1LR-375	M111-37+
38	39	39	M1UR-380	M1UL-380	M1LL-380	M1LR-380	M111-38
38+	39.4	39.35	M1UR-385	M1UL-385	M1LL-385	M1LR-385	M111-38+
39	39.8	39.7	M1UR-390	M1UL-390	M1LL-390	M1LR-390	M111-39
39+	40.2	40	M1UR-395	M1UL-395	M1LL-395	M1LR-395	M111-39+
40	41	40.5	M1UR-400	M1UL-400	M1LL-400	M1LR-400	M111-40
40+	41.5	41	M1UR-405	M1UL-405	M1LL-405	M1LR-405	M111-40+
41	42	41.5	M1UR-410	M1UL-410	M1LL-410	M1LR-410	M111-41
41+	42.5	42	M1UR-415	M1UL-415	M1LL-415	M1LR-415	M111-41+
42	43	42.5	M1UR-420	M1UL-420	M1LL-420	M1LR-420	M111-42
42+	43.5	43	M1UR-425	M1UL-425	M1LL-425	M1LR-425	M111-42+
43	44	43.5	M1UR-430	M1UL-430	M1LL-430	M1LR-430	M111-43
43+	44.5	44	M1UR-435	M1UL-435	M1LL-435	M1LR-435	M111-43+
44	45	44.5	M1UR-440	M1UL-440	M1LL-440	M1LR-440	M111-44
44+	44.5	45	M1UR-445	M1UL-445	M1LL-445	M1LR-445	M111-44+

Space Maintainer >>



2nd Molar M Series

TYPE	Perimeter(mm)		Item NO.				Set
			Tooth		Tooth		
	upper	Lower	UR	UL	LL	LR	
28	28.8	29	M2UR-280	M2UL-280	M2LL-280	M2LR-280	M211-28
28+	29.3	29.5	M2UR-285	M2UL-285	M2LL-285	M2LR-285	M211-28+
29	29.8	30	M2UR-290	M2UL-290	M2LL-290	M2LR-290	M211-29
29+	30.3	30.5	M2UR-295	M2UL-295	M2LL-295	M2LR-295	M211-29+
30	30.8	31.5	M2UR-300	M2UL-300	M2LL-300	M2LR-300	M211-30
30+	31.3	31.9	M2UR-305	M2UL-305	M2LL-305	M2LR-305	M211-30+
31	31.8	32.3	M2UR-310	M2UL-310	M2LL-310	M2LR-310	M211-31
31+	32.2	32.6	M2UR-315	M2UL-315	M2LL-315	M2LR-315	M211-31+
32	32.6	33.4	M2UR-320	M2UL-320	M2LL-320	M2LR-320	M211-32
32+	33	33.8	M2UR-325	M2UL-325	M2LL-325	M2LR-325	M211-32+
33	33.4	34.2	M2UR-330	M2UL-330	M2LL-330	M2LR-330	M211-33
33+	33.8	34.6	M2UR-335	M2UL-335	M2LL-335	M2LR-335	M211-33+
34	34.6	35.4	M2UR-340	M2UL-340	M2LL-340	M2LR-340	M211-34
34+	35	35.8	M2UR-345	M2UL-345	M2LL-345	M2LR-345	M211-34+
35	35.4	36.2	M2UR-350	M2UL-350	M2LL-350	M2LR-350	M211-35
35+	35.8	36.5	M2UR-355	M2UL-355	M2LL-355	M2LR-355	M211-35+
36	36.2	37	M2UR-360	M2UL-360	M2LL-360	M2LR-360	M211-36
36+	37	37.4	M2UR-365	M2UL-365	M2LL-365	M2LR-365	M211-36+
37	37.8	38.2	M2UR-370	M2UL-370	M2LL-370	M2LR-370	M211-37
37+	38.6	38.6	M2UR-375	M2UL-375	M2LL-375	M2LR-375	M211-37+
38	39	39	M2UR-380	M2UL-380	M2LL-380	M2LR-380	M211-38
38+	39.4	39.35	M2UR-385	M2UL-385	M2LL-385	M2LR-385	M211-38+
39	39.8	39.7	M2UR-390	M2UL-390	M2LL-390	M2LR-390	M211-39
39+	40.2	40	M2UR-395	M2UL-395	M2LL-395	M2LR-395	M211-39+
40	41	40.5	M2UR-400	M2UL-400	M2LL-400	M2LR-400	M211-40
40+	41.5	41	M2UR-405	M2UL-405	M2LL-405	M2LR-405	M211-40+
41	42	41.5	M2UR-410	M2UL-410	M2LL-410	M2LR-410	M211-41
41+	42.5	42	M2UR-415	M2UL-415	M2LL-415	M2LR-415	M211-41+
42	43	42.5	M2UR-420	M2UL-420	M2LL-420	M2LR-420	M211-42
42+	43.5	43	M2UR-425	M2UL-425	M2LL-425	M2LR-425	M211-42+
43	44	43.5	M2UR-430	M2UL-430	M2LL-430	M2LR-430	M211-43
43+	44.5	44	M2UR-435	M2UL-435	M2LL-435	M2LR-435	M211-43+
44	45	44.5	M2UR-440	M2UL-440	M2LL-440	M2LR-440	M211-44

Space Maintainer >>



1st Molar G Series

TYPE	Perimeter(mm)		Item NO.				Set
			Tooth		Tooth		
	upper	Lower	UR	UL	LL	LR	
1	29.75	29.75	G1UR-01	G1UL-01	G1LL-01	G1LR-01	G111-01
2	30.5	30.5	G1UR-02	G1UL-02	G1LL-02	G1LR-02	G111-02
3	31.25	31.25	G1UR-03	G1UL-03	G1LL-03	G1LR-03	G111-03
4	31.75	31.75	G1UR-04	G1UL-04	G1LL-04	G1LR-04	G111-04
5	32.25	32.25	G1UR-05	G1UL-05	G1LL-05	G1LR-05	G111-05
6	32.75	32.75	G1UR-06	G1UL-06	G1LL-06	G1LR-06	G111-06
7	33.5	33.4	G1UR-07	G1UL-07	G1LL-07	G1LR-07	G111-07
8	34	33.9	G1UR-08	G1UL-08	G1LL-08	G1LR-08	G111-08
9	34.5	34.3	G1UR-09	G1UL-09	G1LL-09	G1LR-09	G111-09
10	34.9	34.7	G1UR-10	G1UL-10	G1LL-10	G1LR-10	G111-10
11	35.3	35.1	G1UR-11	G1UL-11	G1LL-11	G1LR-11	G111-11
12	35.7	35.4	G1UR-12	G1UL-12	G1LL-12	G1LR-12	G111-12
13	36.1	35.75	G1UR-13	G1UL-13	G1LL-13	G1LR-13	G111-13
14	36.5	36.1	G1UR-14	G1UL-14	G1LL-14	G1LR-14	G111-14
15	36.9	36.4	G1UR-15	G1UL-15	G1LL-15	G1LR-15	G111-15
16	37.3	36.8	G1UR-16	G1UL-16	G1LL-16	G1LR-16	G111-16
17	37.7	37.2	G1UR-17	G1UL-17	G1LL-17	G1LR-17	G111-17
18	38.1	37.6	G1UR-18	G1UL-18	G1LL-18	G1LR-18	G111-18
19	38.4	38	G1UR-19	G1UL-19	G1LL-19	G1LR-19	G111-19
20	38.7	38.4	G1UR-20	G1UL-20	G1LL-20	G1LR-20	G111-20
21	39.1	38.8	G1UR-21	G1UL-21	G1LL-21	G1LR-21	G111-21
22	39.5	39.2	G1UR-22	G1UL-22	G1LL-22	G1LR-22	G111-22
23	39.9	39.6	G1UR-23	G1UL-23	G1LL-23	G1LR-23	G111-23
24	40.3	40	G1UR-24	G1UL-24	G1LL-24	G1LR-24	G111-24
25	40.7	40.4	G1UR-25	G1UL-25	G1LL-25	G1LR-25	G111-25
26	41.1	40.8	G1UR-26	G1UL-26	G1LL-26	G1LR-26	G111-26
27	41.5	41.2	G1UR-27	G1UL-27	G1LL-27	G1LR-27	G111-27
28	41.9	41.75	G1UR-28	G1UL-28	G1LL-28	G1LR-28	G111-28
29	42.3	42.5	G1UR-29	G1UL-29	G1LL-29	G1LR-29	G111-29
30	42.7	43.25	G1UR-30	G1UL-30	G1LL-30	G1LR-30	G111-30
31	43.1	44	G1UR-31	G1UL-31	G1LL-31	G1LR-31	G111-31
32	43.5	44.5	G1UR-32	G1UL-32	G1LL-32	G1LR-32	G111-32

Space Maintainer >>



2nd Molar G Series

TYPE	Perimeter(mm)		Item NO.				Set
			Tooth		Tooth		
	upper	Lower	UR	UL	LL	LR	
1	28.8	28.5	G2UR-01	G2UL-01	G2LL-01	G2LR-01	G211-01
2	29.3	29	G2UR-02	G2UL-02	G2LL-02	G2LR-02	G211-02
3	29.8	29.5	G2UR-03	G2UL-03	G2LL-03	G2LR-03	G211-03
4	30.3	30	G2UR-04	G2UL-04	G2LL-04	G2LR-04	G211-04
5	30.8	30.5	G2UR-05	G2UL-05	G2LL-05	G2LR-05	G211-05
6	31.3	31	G2UR-06	G2UL-06	G2LL-06	G2LR-06	G211-06
7	31.8	31.5	G2UR-07	G2UL-07	G2LL-07	G2LR-07	G211-07
8	32.2	31.9	G2UR-08	G2UL-08	G2LL-08	G2LR-08	G211-08
9	32.6	32.3	G2UR-09	G2UL-09	G2LL-09	G2LR-09	G211-09
10	33	32.6	G2UR-10	G2UL-10	G2LL-10	G2LR-10	G211-10
11	33.4	33	G2UR-11	G2UL-11	G2LL-11	G2LR-11	G211-11
12	33.8	33.4	G2UR-12	G2UL-12	G2LL-12	G2LR-12	G211-12
13	34.2	33.8	G2UR-13	G2UL-13	G2LL-13	G2LR-13	G211-13
14	34.6	34.2	G2UR-14	G2UL-14	G2LL-14	G2LR-14	G211-14
15	35	34.6	G2UR-15	G2UL-15	G2LL-15	G2LR-15	G211-15
16	35.4	35	G2UR-16	G2UL-16	G2LL-16	G2LR-16	G211-16
17	35.8	35.4	G2UR-17	G2UL-17	G2LL-17	G2LR-17	G211-17
18	36.2	35.8	G2UR-18	G2UL-18	G2LL-18	G2LR-18	G211-18
19	37	36.2	G2UR-19	G2UL-19	G2LL-19	G2LR-19	G211-19
20	37.4	36.5	G2UR-20	G2UL-20	G2LL-20	G2LR-20	G211-20
21	37.8	37	G2UR-21	G2UL-21	G2LL-21	G2LR-21	G211-21
22	38.2	37.4	G2UR-22	G2UL-22	G2LL-22	G2LR-22	G211-22
23	38.6	37.8	G2UR-23	G2UL-23	G2LL-23	G2LR-23	G211-23
24	39	38.2	G2UR-24	G2UL-24	G2LL-24	G2LR-24	G211-24
25	39.4	38.6	G2UR-25	G2UL-25	G2LL-25	G2LR-25	G211-25
26	39.8	39	G2UR-26	G2UL-26	G2LL-26	G2LR-26	G211-26
27	40.2	39.35	G2UR-27	G2UL-27	G2LL-27	G2LR-27	G211-27
28	40.6	39.7	G2UR-28	G2UL-28	G2LL-28	G2LR-28	G211-28
29	41	40	G2UR-29	G2UL-29	G2LL-29	G2LR-29	G211-29
30	41.5	40.5	G2UR-30	G2UL-30	G2LL-30	G2LR-30	G211-30

KIDS Space Maintainer >>



TYPE	Perimeter (mm)		Item NO.	
			Tooth	
	Upper/Lower		Upper/Lower	
23	23		B4-230	
23.5	23.5		B4-235	
24	24		B4-240	
24.5	24.5		B4-245	
25	25		B4-250	
25.5	25.5		B4-255	
26	26		B4-260	
26.5	26.5		B4-260	
27	27		B4-270	
27.5	27.5		B4-275	
28	28		B4-280	
28.5	28.5		B4-285	
29	29		B4-290	
29.5	29.5		B4-295	
30	30		B4-300	
30.5	30.5		B4-305	
31	31		B4-310	
31.5	31.5		B4-315	
32	32		B4-320	
32.5	32.5		B4-325	

TYPE	Perimeter (mm)		Item NO.	
			Tooth	
	Upper/Lower		Upper/Lower	
33	33		B4-330	
33.5	33.5		B4-335	
34	34		B4-340	
34.5	34.5		B4-345	
35	35		B4-350	
35.5	35.5		B4-355	
36	36		B4-360	
36.5	36.5		B4-365	
37	37		B4-370	
37.5	37.5		B4-375	
38	38		B4-380	
38.5	38.5		B4-385	
39	39		B4-390	
39.5	39.5		B4-395	
40	40		B4-400	
40.5	40.5		B4-405	
41	41		B4-410	
41.5	41.5		B4-415	
42	42		B4-420	

Kids Space Maintainer



	Specification	Item NO.	Product
	Tube	FETD-00	
	Plain Wires Long	FETD-01	
	Plain Wires Middle	FETD-02	
	Plain Wires Short	FETD-03	
	Drop Wires	FETD-04	
	Distal Shoe Wires	FETD-05	

Archwires & Springs



1box(5bags upper+5bags lower)

Archwires >>

• Super Elastic NITI Archwire

Round	Size	Square	Ovoid	Natural	Package
Upper	0.012"/0.31mm	FN111-1U	FN112-1U	FN113-1U	10*1/bag
	0.014"/0.35mm	FN111-2U	FN112-2U	FN113-2U	
	0.016"/0.41mm	FN111-3U	FN112-3U	FN113-3U	
	0.018"/0.46mm	FN111-4U	FN112-4U	FN113-4U	
	0.020"/0.51mm	FN111-5U	FN112-5U	FN113-5U	
Lower	0.012"/0.31mm	FN111-1L	FN112-1L	FN113-1L	100*1/box
	0.014"/0.35mm	FN111-2L	FN112-2L	FN113-2L	
	0.016"/0.41mm	FN111-3L	FN112-3L	FN113-3L	
	0.018"/0.46mm	FN111-4L	FN112-4L	FN113-4L	
	0.020"/0.51mm	FN111-5L	FN112-5L	FN113-5L	

Rectangular	Size	Square	Ovoid	Natural	Package
Upper	0.014X0.025"/0.35X0.64mm	FN121-0U	FN122-0U	FN123-0U	10*1/bag
	0.016X0.016"/0.41X0.41mm	FN121-1U	FN122-1U	FN123-1U	
	0.016X0.022"/0.41X0.56mm	FN121-2U	FN122-2U	FN123-2U	
	0.016X0.025"/0.41X0.64mm	FN121-02U	FN122-02U	FN123-02U	
	0.017X0.022"/0.43X0.56mm	FN121-3U	FN122-3U	FN123-3U	
	0.017X0.025"/0.43X0.64mm	FN121-4U	FN122-4U	FN123-4U	
	0.018X0.018"/0.46X0.46mm	FN121-05U	FN122-05U	FN123-05U	
	0.018X0.022"/0.46X0.56mm	FN121-5U	FN122-5U	FN123-5U	
	0.018X0.025"/0.46X0.64mm	FN121-6U	FN122-6U	FN123-6U	
	0.019X0.025"/0.48X0.64mm	FN121-7U	FN122-7U	FN123-7U	
	0.020X0.020"/0.51X0.51mm	FN121-08U	FN122-08U	FN123-08U	
	0.021X0.025"/0.53X0.64mm	FN121-8U	FN122-8U	FN123-8U	
	Lower	0.014X0.025"/0.35X0.64mm	FN121-0L	FN122-0L	
0.016X0.016"/0.41X0.41mm		FN121-1L	FN122-1L	FN123-1L	
0.016X0.022"/0.41X0.56mm		FN121-2L	FN122-2L	FN123-2L	
0.016X0.025"/0.41X0.64mm		FN121-02L	FN122-02L	FN123-02L	
0.017X0.022"/0.43X0.56mm		FN121-3L	FN122-3L	FN123-3L	
0.017X0.025"/0.43X0.64mm		FN121-4L	FN122-4L	FN123-4L	
0.018X0.018"/0.46X0.46mm		FN121-05L	FN122-05L	FN123-05L	
0.018X0.022"/0.46X0.56mm		FN121-5L	FN122-5L	FN123-5L	
0.018X0.025"/0.46X0.64mm		FN121-6L	FN122-6L	FN123-6L	
0.019X0.025"/0.48X0.64mm		FN121-7L	FN122-7L	FN123-7L	
0.020X0.020"/0.51X0.51mm		FN121-08L	FN122-08L	FN123-08L	
0.021X0.025"/0.53X0.64mm		FN121-8L	FN122-8L	FN123-8L	

• Thermal Active NITI Archwire

Round	Size	Square	Ovoid	Natural	Package
Upper	0.012"/0.31mm	FN211-1U	FN212-1U	FN213-1U	10*1/bag
	0.014"/0.35mm	FN211-2U	FN212-2U	FN213-2U	
	0.016"/0.41mm	FN211-3U	FN212-3U	FN213-3U	
	0.018"/0.46mm	FN211-4U	FN212-4U	FN213-4U	
	0.020"/0.51mm	FN211-5U	FN212-5U	FN213-5U	
Lower	0.012"/0.31mm	FN211-1L	FN212-1L	FN213-1L	100*1/box
	0.014"/0.35mm	FN211-2L	FN212-2L	FN213-2L	
	0.016"/0.41mm	FN211-3L	FN212-3L	FN213-3L	
	0.018"/0.46mm	FN211-4L	FN212-4L	FN213-4L	
	0.020"/0.51mm	FN211-5L	FN212-5L	FN213-5L	

Rectangular	Size	Square	Ovoid	Natural	Package
Upper	0.014X0.025"/0.35X0.64mm	FN221-0U	FN222-0U	FN223-0U	10*1/bag
	0.016X0.016"/0.41X0.41mm	FN221-1U	FN222-1U	FN223-1U	
	0.016X0.022"/0.41X0.56mm	FN221-2U	FN222-2U	FN223-2U	
	0.016X0.025"/0.41X0.64mm	FN221-02U	FN222-02U	FN223-02U	
	0.017X0.022"/0.43X0.56mm	FN221-3U	FN222-3U	FN223-3U	
	0.017X0.025"/0.43X0.64mm	FN221-4U	FN222-4U	FN223-4U	
	0.018X0.018"/0.46X0.46mm	FN221-05U	FN222-05U	FN223-05U	
	0.018X0.022"/0.46X0.56mm	FN221-5U	FN222-5U	FN223-5U	
	0.018X0.025"/0.46X0.64mm	FN221-6U	FN222-6U	FN223-6U	
	0.019X0.025"/0.48X0.64mm	FN221-7U	FN222-7U	FN223-7U	
	0.020X0.020"/0.51X0.51mm	FN221-08U	FN222-08U	FN223-08U	
	0.021X0.025"/0.53X0.64mm	FN221-8U	FN222-8U	FN223-8U	
	Lower	0.014X0.025"/0.35X0.64mm	FN221-0L	FN222-0L	
0.016X0.016"/0.41X0.41mm		FN221-1L	FN222-1L	FN223-1L	
0.016X0.022"/0.41X0.56mm		FN221-2L	FN222-2L	FN223-2L	
0.016X0.025"/0.41X0.64mm		FN221-02L	FN222-02L	FN223-02L	
0.017X0.022"/0.43X0.56mm		FN221-3L	FN222-3L	FN223-3L	
0.017X0.025"/0.43X0.64mm		FN221-4L	FN222-4L	FN223-4L	
0.018X0.018"/0.46X0.46mm		FN221-05L	FN222-05L	FN223-05L	
0.018X0.022"/0.46X0.56mm		FN221-5L	FN222-5L	FN223-5L	
0.018X0.025"/0.46X0.64mm		FN221-6L	FN222-6L	FN223-6L	
0.019X0.025"/0.48X0.64mm		FN221-7L	FN222-7L	FN223-7L	
0.020X0.020"/0.51X0.51mm		FN221-08L	FN222-08L	FN223-08L	
0.021X0.025"/0.53X0.64mm		FN221-8L	FN222-8L	FN223-8L	

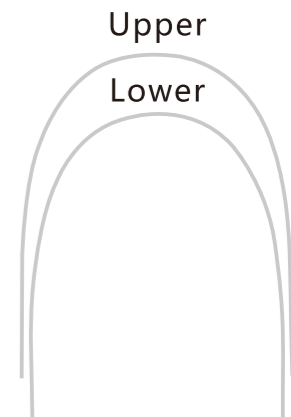

Square

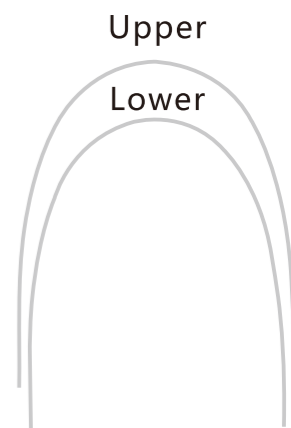

Ovoid

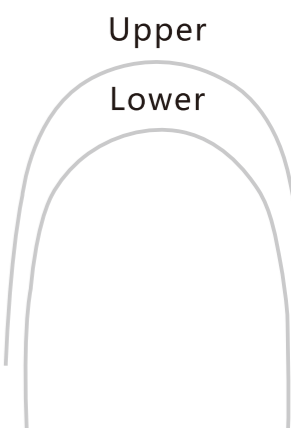

Natural

Archwires >>

• Stainless Steel Archwire

Round	Size	Square	Ovoid	Natural	Package
Upper	0.012"/0.31mm	FN411-1U	FN412-1U	FN413-1U	10*1/bag 100*1/box
	0.014"/0.35mm	FN411-2U	FN412-2U	FN413-2U	
	0.016"/0.41mm	FN411-3U	FN412-3U	FN413-3U	
	0.018"/0.46mm	FN411-4U	FN412-4U	FN413-4U	
	0.020"/0.51mm	FN411-5U	FN412-5U	FN413-5U	
Lower	0.012"/0.31mm	FN411-1L	FN412-1L	FN413-1L	
	0.014"/0.35mm	FN411-2L	FN412-2L	FN413-2L	
	0.016"/0.41mm	FN411-3L	FN412-3L	FN413-3L	
	0.018"/0.46mm	FN411-4L	FN412-4L	FN413-4L	
	0.020"/0.51mm	FN411-5L	FN412-5L	FN413-5L	

Rectangular	Size	Square	Ovoid	Natural	Package
Upper	0.014X0.025"/0.35X0.64mm	FN421-0U	FN422-0U	FN423-0U	10*1/bag 100*1/box
	0.016X0.016"/0.41X0.41mm	FN421-1U	FN422-1U	FN423-1U	
	0.016X0.022"/0.41X0.56mm	FN421-2U	FN422-2U	FN423-2U	
	0.016X0.025"/0.41X0.64mm	FN421-02U	FN422-02U	FN423-02U	
	0.017X0.022"/0.43X0.56mm	FN421-3U	FN422-3U	FN423-3U	
	0.017X0.025"/0.43X0.64mm	FN421-4U	FN422-4U	FN423-4U	
	0.018X0.018"/0.46X0.46mm	FN421-05U	FN422-05U	FN423-05U	
	0.018X0.022"/0.46X0.56mm	FN421-5U	FN422-5U	FN423-5U	
	0.018X0.025"/0.46X0.64mm	FN421-6U	FN422-6U	FN423-6U	
	0.019X0.025"/0.48X0.64mm	FN421-7U	FN422-7U	FN423-7U	
	0.020X0.020"/0.51X0.51mm	FN421-08U	FN422-08U	FN423-08U	
	0.021X0.025"/0.53X0.64mm	FN421-8U	FN422-8U	FN423-8U	
Lower	0.014X0.025"/0.35X0.64mm	FN421-0L	FN422-0L	FN423-0L	100*1/box
	0.016X0.016"/0.41X0.41mm	FN421-1L	FN422-1L	FN423-1L	
	0.016X0.022"/0.41X0.56mm	FN421-2L	FN422-2L	FN423-2L	
	0.016X0.025"/0.41X0.64mm	FN421-02L	FN422-02L	FN423-02L	
	0.017X0.022"/0.43X0.56mm	FN421-3L	FN422-3L	FN423-3L	
	0.017X0.025"/0.43X0.64mm	FN421-4L	FN422-4L	FN423-4L	
	0.018X0.018"/0.46X0.46mm	FN421-05L	FN422-05L	FN423-05L	
	0.018X0.022"/0.46X0.56mm	FN421-5L	FN422-5L	FN423-5L	
	0.018X0.025"/0.46X0.64mm	FN421-6L	FN422-6L	FN423-6L	
	0.019X0.025"/0.48X0.64mm	FN421-7L	FN422-7L	FN423-7L	
	0.020X0.020"/0.51X0.51mm	FN421-08L	FN422-08L	FN423-08L	
	0.021X0.025"/0.53X0.64mm	FN421-8L	FN422-8L	FN423-8L	

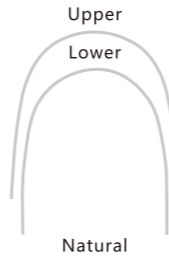
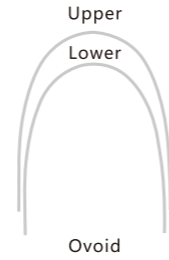
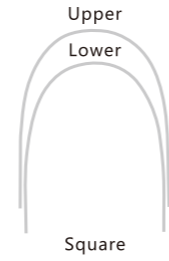

• Reverse Curve NITI Wire

Round	Size	Ovoid	Natural	Package
Upper	0.012"/0.31mm	FN311-1U	FN312-1U	2*1/bag 10*1/bag
	0.014"/0.35mm	FN311-2U	FN312-2U	
	0.016"/0.41mm	FN311-3U	FN312-3U	
	0.018"/0.46mm	FN311-4U	FN312-4U	
	0.020"/0.51mm	FN311-5U	FN312-5U	
Lower	0.012"/0.31mm	FN311-1L	FN312-1L	
	0.014"/0.35mm	FN311-2L	FN312-2L	
	0.016"/0.41mm	FN311-3L	FN312-3L	
	0.018"/0.46mm	FN311-4L	FN312-4L	
	0.020"/0.51mm	FN311-5L	FN312-5L	

Rectangular	Size	Ovoid	Natural	Package		
Upper	0.014 x 0.025"/0.36 x 0.64mm	FN321-0U	FN322-0U	2*1/bag 10*1/bag		
	0.016X0.016"/0.41X0.41mm	FN321-1U	FN322-1U			
	0.016X0.022"/0.41X0.56mm	FN321-2U	FN322-2U			
	0.016x0.025"/0.41x0.64mm	FN321-02U	FN322-02U			
	0.017X0.022"/0.43X0.56mm	FN321-3U	FN322-3U			
	0.017X0.025"/0.43X0.64mm	FN321-4U	FN322-4U			
	0.018X0.022"/0.46X0.56mm	FN321-5U	FN322-5U			
	0.018X0.025"/0.46X0.64mm	FN321-6U	FN322-6U			
	0.019X0.025"/0.48X0.64mm	FN321-7U	FN322-7U			
	0.021X0.025"/0.53X0.64mm	FN321-8U	FN322-8U			
	Lower	0.014 x 0.025"/0.36 x 0.64mm	FN321-0L		FN322-0L	10*1/bag
		0.016X0.016"/0.41X0.41mm	FN321-1L		FN322-1L	
0.016X0.022"/0.41X0.56mm		FN321-2L	FN322-2L			
0.016 x 0.025"/0.41 x 0.64mm		FN321-02L	FN322-02L			
0.017X0.022"/0.43X0.56mm		FN321-3L	FN322-3L			
0.017X0.025"/0.43X0.64mm		FN321-4L	FN322-4L			
0.018X0.022"/0.46X0.56mm		FN321-5L	FN322-5L			
0.018X0.025"/0.46X0.64mm		FN321-6L	FN322-6L			
0.019X0.025"/0.48X0.64mm		FN321-7L	FN322-7L			
0.021X0.025"/0.53X0.64mm		FN321-8L	FN322-8L			

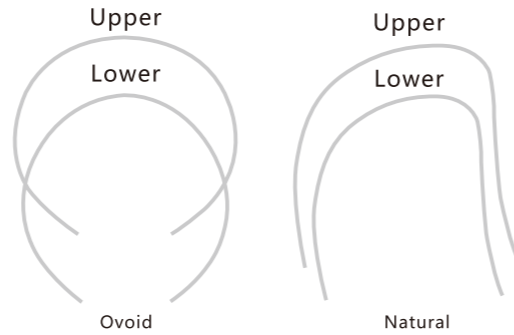

Archwires >>

• Coated Super Elastic Niti Archwires (White)

Round	Size	Ovoid	Package
Upper	0.012"/0.31mm	FN112-1UW	1*1/bag
	0.014"/0.35mm	FN112-2UW	
	0.016"/0.41mm	FN112-3UW	
	0.018"/0.46mm	FN112-4UW	
	0.020"/0.51mm	FN112-5UW	
Lower	0.012"/0.31mm	FN112-1LW	
	0.014"/0.35mm	FN112-2LW	
	0.016"/0.41mm	FN112-3LW	
	0.018"/0.46mm	FN112-4LW	
	0.020"/0.51mm	FN112-5LW	

Rectangular	Size	Ovoid	Package		
Upper	0.016X0.016"/0.41X0.41mm	FN122-1UW	1*1/bag		
	0.016X0.022"/0.41X0.56mm	FN122-2UW			
	0.017X0.022"/0.43X0.56mm	FN122-3UW			
	0.017X0.025"/0.43X0.64mm	FN122-4UW			
	0.018X0.022"/0.46X0.56mm	FN122-5UW			
	0.018X0.025"/0.46X0.64mm	FN122-6UW			
	0.019X0.025"/0.48X0.64mm	FN122-7UW			
	0.021X0.025"/0.53X0.64mm	FN122-8UW			
	Lower	0.016X0.016"/0.41X0.41mm		FN122-1LW	1*1/bag
		0.016X0.022"/0.41X0.56mm		FN122-2LW	
		0.017X0.022"/0.43X0.56mm		FN122-3LW	
		0.017X0.025"/0.43X0.64mm		FN122-4LW	
0.018X0.022"/0.46X0.56mm		FN122-5LW			
0.018X0.025"/0.46X0.64mm		FN122-6LW			
0.019X0.025"/0.48X0.64mm		FN122-7LW			
0.021X0.025"/0.53X0.64mm		FN122-8LW			

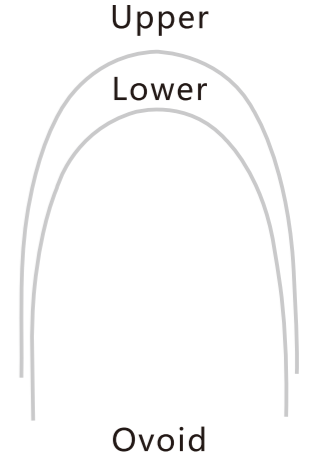

Other colors can be customized as required (such as Red/Yellow/Blue/Green/Purple/Pink)

• Coated Stainless Steel Archwires (White)

Round	Size	Ovoid	Package
Upper	0.012"/0.31mm	FN412-1UW	1*1/bag
	0.014"/0.35mm	FN412-2UW	
	0.016"/0.41mm	FN412-3UW	
	0.018"/0.46mm	FN412-4UW	
	0.020"/0.51mm	FN412-5UW	
Lower	0.012"/0.31mm	FN412-1LW	
	0.014"/0.35mm	FN412-2LW	
	0.016"/0.41mm	FN412-3LW	
	0.018"/0.46mm	FN412-4LW	
	0.020"/0.51mm	FN412-5LW	

Rectangular	Size	Ovoid	Package		
Upper	0.016X0.016"/0.41X0.41mm	FN422-1UW	1*1/bag		
	0.016X0.022"/0.41X0.56mm	FN422-2UW			
	0.017X0.022"/0.43X0.56mm	FN422-3UW			
	0.017X0.025"/0.43X0.64mm	FN422-4UW			
	0.018X0.022"/0.46X0.56mm	FN422-5UW			
	0.018X0.025"/0.46X0.64mm	FN422-6UW			
	0.019X0.025"/0.48X0.64mm	FN422-7UW			
	0.021X0.025"/0.53X0.64mm	FN422-8UW			
	Lower	0.016X0.016"/0.41X0.41mm		FN422-1LW	1*1/bag
		0.016X0.022"/0.41X0.56mm		FN422-2LW	
		0.017X0.022"/0.43X0.56mm		FN422-3LW	
		0.017X0.025"/0.43X0.64mm		FN422-4LW	
0.018X0.022"/0.46X0.56mm		FN422-5LW			
0.018X0.025"/0.46X0.64mm		FN422-6LW			
0.019X0.025"/0.48X0.64mm		FN422-7LW			
0.021X0.025"/0.53X0.64mm		FN422-8LW			

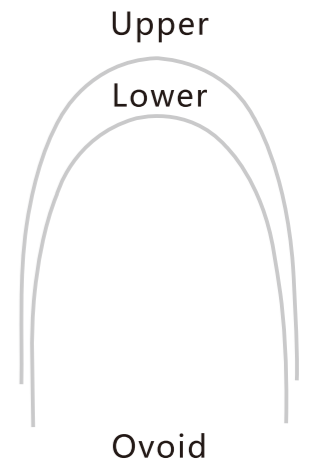

Archwires >>

• Lingual Archwires

Round	Size	Item No.	Package
Upper	0.012"/0.31mm	FN511-1U	1*1/bag
	0.014"/0.35mm	FN511-2U	
	0.016"/0.41mm	FN511-3U	
	0.018"/0.46mm	FN511-4U	
	0.020"/0.51mm	FN511-5U	
Lower	0.012"/0.31mm	FN511-1L	
	0.014"/0.35mm	FN511-2L	
	0.016"/0.41mm	FN511-3L	
	0.018"/0.46mm	FN511-4L	
	0.020"/0.51mm	FN511-5L	

Rectangular	Size	Item No.	Package
Upper	0.016X0.016"/0.41X0.41mm	FN521-1U	1*1/bag
	0.016X0.022"/0.41X0.56mm	FN521-2U	
	0.017X0.025"/0.43X0.64mm	FN521-3U	
	0.018X0.025"/0.46X0.64mm	FN521-4U	
	0.019X0.025"/0.48X0.64mm	FN521-5U	
	0.021X0.025"/0.53X0.64mm	FN521-6U	
Lower	0.016X0.016"/0.41X0.41mm	FN521-1L	
	0.016X0.022"/0.41X0.56mm	FN521-2L	
	0.017X0.025"/0.43X0.64mm	FN521-3L	
	0.018X0.025"/0.46X0.64mm	FN521-4L	
	0.019X0.025"/0.48X0.64mm	FN521-5L	
	0.021X0.025"/0.53X0.64mm	FN521-6L	

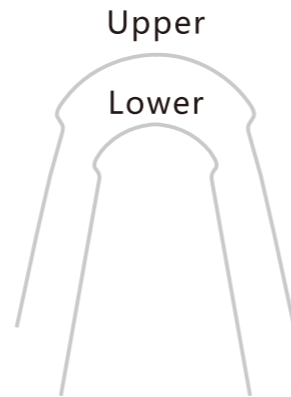

• CU-NITI Wires

Round	Size	Without stop	With stop	Package
Round	0.013"/0.33mm	FN711-1	FN711-11	1*1/bag
	0.014"/0.35mm	FN711-2	FN711-12	
	0.016"/0.41mm	FN711-3	FN711-13	
	0.018"/0.46mm	FN711-4	FN711-14	

Rectangular	Size	Without stop	With stop	Package
Rectangular	0.014X0.025"/0.35X0.64mm	FN721-1	FN721-11	1*1/bag
	0.016X0.022"/0.41X0.56mm	FN721-2	FN721-12	
	0.016X0.025"/0.41X0.64mm	FN721-3	FN721-13	
	0.017X0.025"/0.43X0.64mm	FN721-31	FN721-131	
	0.018X0.025"/0.46X0.64mm	FN721-4	FN721-14	
	0.019X0.025"/0.48X0.64mm	FN721-5	FN721-15	



Archwires >>

• TMA Archwires

Round	Size	Ovoid	Natural	Package
Upper	0.012"/0.31mm	FN612-1U	FN613-1U	1*1/bag
	0.014"/0.35mm	FN612-2U	FN613-2U	
	0.016"/0.41mm	FN612-3U	FN613-3U	
	0.018"/0.46mm	FN612-4U	FN613-4U	
	0.020"/0.51mm	FN612-5U	FN613-5U	
Lower	0.012"/0.31mm	FN612-1L	FN613-1L	
	0.014"/0.35mm	FN612-2L	FN613-2L	
	0.016"/0.41mm	FN612-3L	FN613-3L	
	0.018"/0.46mm	FN612-4L	FN613-4L	
	0.020"/0.51mm	FN612-5L	FN613-5L	

Rectangular	Size	Ovoid	Natural	Package
Upper	0.016X0.016"/0.41X0.41mm	FN622-1U	FN623-1U	1*1/bag
	0.016X0.022"/0.41X0.56mm	FN622-2U	FN623-2U	
	0.017X0.022"/0.43X0.56mm	FN622-3U	FN623-3U	
	0.017X0.025"/0.43X0.64mm	FN622-4U	FN623-4U	
	0.018X0.025"/0.46X0.64mm	FN622-5U	FN623-5U	
	0.019X0.025"/0.48X0.64mm	FN622-6U	FN623-6U	
	0.021X0.025"/0.53X0.64mm	FN622-7U	FN623-7U	
Lower	0.016X0.016"/0.41X0.41mm	FN622-1L	FN623-1L	
	0.016X0.022"/0.41X0.56mm	FN622-2L	FN623-2L	
	0.017X0.022"/0.43X0.56mm	FN622-3L	FN623-3L	
	0.017X0.025"/0.43X0.64mm	FN622-4L	FN623-4L	
	0.018X0.025"/0.46X0.64mm	FN622-5L	FN623-5L	
	0.019X0.025"/0.48X0.64mm	FN622-6L	FN623-6L	
	0.021X0.025"/0.53X0.64mm	FN622-7L	FN623-7L	

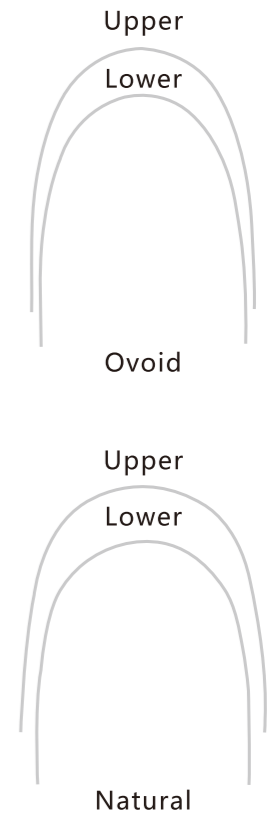

• TMA Wires in Cylinder

Specification	Size	Item No.	Package
	0.016*0.022"	FN611-1	10*1
	0.017*0.025"	FN611-2	
	0.018*0.025"	FN611-3	
	0.019*0.025"	FN611-4	

• Tooth Torque Springs

Specification	Size	Item No.	Package
	16*22 S	TS16-22S	10*1
	16*22 M	TS16-22M	
	16*22 L	TS16-22L	
	17*25 S	TS17-25S	
	17*25 M	TS17-25M	
	17*25 L	TS17-25L	
	18*25 S	TS18-25S	
	18*25 M	TS18-25M	
	18*25 L	TS18-25L	
	19*25 S	TS19-25S	
19*25 M	TS19-25M		
19*25 L	TS19-25L		
	Small	TS11-01	10*1
	Medium	TS11-02	
	Large	TS11-03	

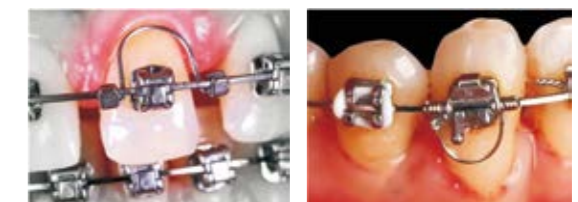

1G

2G

Archwires >>

• Niti Roll (5 meter)

Specification	Size	Item No.	Package
	0.012"/0.31mm	FH04-12	5m*1
	0.014"/0.35mm	FH04-14	
	0.016"/0.41mm	FH04-16	
	0.018"/0.46mm	FH04-18	
	0.020"/0.51mm	FH04-20	

• Australian wires in Cylinder

Specification	Size	Item No.	Package
	0.012"/0.31mm	FN711-1	30*1
	0.014"/0.35mm	FN711-2	
	0.016"/0.41mm	FN711-3	
	0.018"/0.46mm	FN711-4	
	0.020"/0.51mm	FN711-5	

• Australian wires in Roll

Specification	Size	Item No.	Package
	0.012"/0.31mm	FN811-1	7.5m*1
	0.014"/0.35mm	FN811-2	
	0.016"/0.41mm	FN811-3	
	0.018"/0.46mm	FN811-4	
	0.020"/0.51mm	FN811-5	

• Stainless Steel Straight Wire

Specification	Size	Item No.	Package
	0.012"/0.31mm	FN424-1	20*1
	0.014"/0.35mm	FN424-2	
	0.016"/0.41mm	FN424-3	
	0.018"/0.46mm	FN424-4	
	0.020"/0.51mm	FN424-5	

• Stainless Steel Straight Wire (Rectangular)

Specification	Size	Item No.	Package
	0.016x0.016"/0.41x0.41mm	FN424-6	10*1
	0.016x0.022"/0.41x0.56mm	FN424-7	
	0.017x0.022"/0.43x0.56mm	FN424-8	
	0.017x0.025"/0.43x0.64mm	FN424-9	
	0.018x0.022"/0.46x0.56mm	FN424-10	
	0.018x0.025"/0.46x0.64mm	FN424-11	
	0.019x0.025"/0.48x0.64mm	FN424-12	
	0.021x0.025"/0.53x0.64mm	FN424-13	

• Retainer Wire (SS)

Specification	Size	Item No.	Package
	0.010*0.028"	FS06-01	10*1
	0.010*0.032" (length: 150mm/ 60inch)	FS06-02	



• Stainless Steel Retainer Chain Wire

Specification	Size	Item No.	Package
	0.030"	Soft: FS07-01	1m/roll 3.2feet
	0.030"	Hard: FS07-02	

• SS 6 strand braided Co-axial Wires

Specification	Size	Item No.	Package
	0.0155"	FS03-11	4.5m*1
	0.0175"	FS03-12	
	0.0195"	FS03-13	

• Arch Wire Former

Specification	Size	Item No.	Package
	0.016"/0.017"/ 0.018"/0.019"/ 0.022"	F111-01	1*1
	0.016"/0.017"/ 0.018"/0.019"/ 0.022"	F111-02	1*1

• Archwires Display Box

Specification	Size	Item No.	Package
	Round 200*110*185mm	F112-01	1*1
	Rectangular 200*110*185mm	F112-02	1*1

Archwires >>

• Niti Open Spring in Bag

Specification	Size	Item No.	Package
	0.008"/0.20mm	FH02-0818	2*1
	0.010"/0.25mm	FH02-1018	
	0.012"/0.31mm	FH02-1218	
	0.014"/0.35mm	FH02-1418	

• NiTi Open Coil Spring

Specification	Size	Item No.	Package
	0.008"/0.20mm	FH06-0891	1*1
	0.010"/0.25mm	FH06-1091	
	0.012"/0.31mm	FH06-1291	
	0.014"/0.35mm	FH06-1491	

• Niti Close Spring (Same Eyelet)

Specification	Size	Item No.	Package
	3mm(0.008"/0.20mm)	FH03-0803	10*1
	3mm(0.010"/0.25mm)	FH03-1003	
	3mm(0.012"/0.31mm)	FH03-1203	
	3mm(0.014"/0.35mm)	FH03-1403	
	6mm(0.008"/0.20mm)	FH03-0806	
	6mm(0.010"/0.25mm)	FH03-1006	
	6mm(0.012"/0.31mm)	FH03-1206	
	6mm(0.014"/0.35mm)	FH03-1406	
	9mm(0.008"/0.20mm)	FH03-0809	
	9mm(0.010"/0.25mm)	FH03-1009	
	9mm(0.012"/0.31mm)	FH03-1209	
	9mm(0.014"/0.35mm)	FH03-1409	
	12mm(0.008"/0.20mm)	FH03-0812	
	12mm(0.010"/0.25mm)	FH03-1012	
	12mm(0.012"/0.31mm)	FH03-1212	
	12mm(0.014"/0.35mm)	FH03-1412	

• NiTi Close Coil Spring

Specification	Size	Item No.	Package
	0.008"/0.20mm	FH08-0891	1*1
	0.010"/0.25mm	FH08-1091	
	0.012"/0.31mm	FH08-1291	
	0.014"/0.35mm	FH08-1491	

• Niti Distalizing Springs

Specification	Size	Item No.	Package
	180mm (0.010"/0.25mm)	FH05-1018	1*1
	180mm (0.012"/0.31mm)	FH05-1218	

• Stainless Steel Open Coil Spring

Specification	Size	Item No.	Package
	0.008"/0.20mm	FH07-0891	1*1
	0.010"/0.25mm	FH07-1091	
	0.012"/0.31mm	FH07-1291	
	0.014"/0.35mm	FH07-1491	

• Niti Close Spring (Big and Small Eyelet)

Specification	Size	Item No.	Package
	3mm(0.008"/0.20mm)	FH04-0803	10*1
	3mm(0.010"/0.25mm)	FH04-1003	
	3mm(0.012"/0.31mm)	FH04-1203	
	3mm(0.014"/0.35mm)	FH04-1403	
	6mm(0.008"/0.20mm)	FH04-0806	
	6mm(0.010"/0.25mm)	FH04-1006	
	6mm(0.012"/0.31mm)	FH04-1206	
	6mm(0.014"/0.35mm)	FH04-1406	
	9mm(0.008"/0.20mm)	FH04-0809	
	9mm(0.010"/0.25mm)	FH04-1009	
	9mm(0.012"/0.31mm)	FH04-1209	
	9mm(0.014"/0.35mm)	FH04-1409	
	12mm(0.008"/0.20mm)	FH04-0812	
	12mm(0.010"/0.25mm)	FH04-1012	
	12mm(0.012"/0.31mm)	FH04-1212	
	12mm(0.014"/0.35mm)	FH04-1412	

• Stainless Steel Close Coil Spring

Specification	Size	Item No.	Package
	0.008"/0.20mm	FH09-0891	1*1
	0.010"/0.25mm	FH09-1091	
	0.012"/0.31mm	FH09-1291	
	0.014"/0.35mm	FH09-1491	

Archwires >>

• Anterior Root Torquing Auxiliary Arch

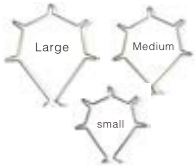
Specification	Size	Item No.	Package
	Maxillary(Small)	AT01-01	10*1
	Maxillary(Medium)	AT01-02	
	Maxillary(Large)	AT01-03	
	Mandibular	AT02-01	



• Separating Spring

Specification	Item No.	Package
 	Universal FS04-01	10*1

• Rotating Spring (cw-ccw)

Specification	Item No.	Package
 	Cw FS05-01 Ccw FS05-02	10*1

• Stainless Steel Ligature Ties (Short)

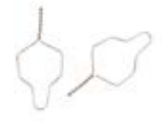
Specification	Size	Item No.	Package
	0.010"/0.25mm	FS01-01	100*1
	0.012"/0.31mm	FS01-02	

• Stainless Steel Ligature Ties (Long)

Specification	Size	Item No.	Package
	0.010"/0.25mm	FS01-03	100*1
	0.012"/0.31mm	FS01-04	

• Kobayashi Ties (Short)

Specification	Size	Item No.	Package
	0.010"/0.25mm	FS02-01	100*1
	0.012"/0.31mm	FS02-02	

• Kobayashi Ties (Long)

Specification	Size	Item No.	Package
	0.010"/0.25mm	FS02-03	100*1
	0.012"/0.31mm	FS02-04	

• Stainless Steel Ligature Wire

Specification	Size	Item No.	Package
	0.20mm (0.08")	FL01-01	1*1 (40g)
	0.25mm (0.10")	FL01-02	
	0.30mm (0.12")	FL01-03	
	0.35mm (0.14")	FL01-04	

Archwires >>

• Stainless steel T Loop Forces

Specification	Size	Distance	Item No.	Package
	17*25	26mm	FN911-101	5*1
		28mm	FN911-102	
		30mm	FN911-103	
		32mm	FN911-104	
		34mm	FN911-105	
		36mm	FN911-106	
		38mm	FN911-107	
		40mm	FN911-108	
		42mm	FN911-109	
		44mm	FN911-110	
	18*25	26mm	FN911-111	5*1
		28mm	FN911-112	
		30mm	FN911-113	
		32mm	FN911-114	
		34mm	FN911-115	
		36mm	FN911-116	
		38mm	FN911-117	
		40mm	FN911-118	
		42mm	FN911-119	
		44mm	FN911-120	
	19*25	26mm	FN911-121	5*1
		28mm	FN911-122	
		30mm	FN911-123	
		32mm	FN911-124	
		34mm	FN911-125	
		36mm	FN911-126	
		38mm	FN911-127	
		40mm	FN911-128	
		42mm	FN911-129	
		44mm	FN911-130	

• Wrap Around Retainer Hawley

Specification	Size	Item No.	Package	
	Upper	Upper36	FN911-36U	5*1
		Upper38	FN911-38U	
		Upper40	FN911-40U	
	Lower	Lower40	FN911-40L	
		Lower43	FN911-43L	
		Lower46	FN911-46L	

• Interproximal Enamel Reduction

Specification	Size	Item No.	Package
	4mm	FSTJ-01	1*1

• Stainless Steel Electroplated Abrasive Strips

Specification	Size	Item No.	Package
	4mm	F120-01	12*1

Elastic-Ring



- Ligature Tie 127
- Power Chain 129
- Two Tone Ligature Tie & Power Chain 131
- Glow In The Dark Ligature Tie 131
- O-Rings..... 132
- Elastic Directors 134
- Elastic Thread (Solid) 134
- Tissue Guard (Archwire Sleeve) 134
- Separators 134
- Ligature Gun 134
- Cartoon Ligature Tie 134
- Personalized Ligature Tie 134
- Ligature Tie Placer 134
- Rotating Wedge 134
- Lip Bumper For Braces 134
- Mini Orthodontic Accessories Injection Mould 135

Elastic-Ring >>

FE12-01	FE12-02	FE12-03	FE12-04
FE12-05	FE12-06	FE12-07	FE12-08
FE12-09	FE12-10	FE12-11	FE12-12
FE12-13	FE12-14	FE12-15	FE12-16
FE12-17	FE12-18	FE12-19	FE12-20
FE12-21	FE12-22	FE12-23	FE12-24
FE12-25	FE12-26	FE12-27	FE12-28
FE12-29	FE12-30	FE12-31	FE12-32
FE12-33	FE12-34	FE12-35	FE12-36

Elastic-Ring >>

• Ligature Tie

Color	ITEM NO. TYPE T	Package	Color	ITEM NO. TYPE T	Package
	Mix Color FE12-00	40*26 1040pcs/bag		Light violet FE12-19	40*26 1040pcs/bag
	Royal purple FE12-01			Neon purple FE12-20	
	Baby blue FE12-02			Light pink FE12-21	
	Sky blue FE12-03			Hot pink FE12-22	
	Dark brown FE12-04			Red FE12-23	
	Spring green FE12-05			Dark red FE12-24	
	Dark green FE12-06			Apple green FE12-25	
	Forest green FE12-07			Turquoise FE12-26	
	Grass green FE12-08			Lake blue FE12-27	
	Orange FE12-09			Rust red FE12-28	
	Mustard yellow FE12-10			Dark blue FE12-29	
	White FE12-11			Prussian blue FE12-30	
	Clear FE12-12			Violet FE12-31	
	Silver FE12-13			Bright green FE12-32	
	Brown FE12-14			Lavender FE12-33	
	Warm orange FE12-15			Dark black FE12-34	
	Banana yellow FE12-16			Deep pink FE12-35	
	Yellow FE12-17			Coral FE12-36	
	Deep purple FE12-18				



Type T Package: 1040pcs/bag



Elastic-Ring >>

Elastic-Ring >>

• Power Chain

Color	ITEM NO.			Package
	long	short	continue	
Royal purple	FE21-01	FE22-01	FE23-01	15feet/roll
Baby blue	FE21-02	FE22-02	FE23-02	
Sky blue	FE21-03	FE22-03	FE23-03	
Dark brown	FE21-04	FE22-04	FE23-04	
Spring green	FE21-05	FE22-05	FE23-05	
Dark green	FE21-06	FE22-06	FE23-06	
Forest green	FE21-07	FE22-07	FE23-07	
Grass green	FE21-08	FE22-08	FE23-08	
Orange	FE21-09	FE22-09	FE23-09	
Mustard yellow	FE21-10	FE22-10	FE23-10	
White	FE21-11	FE22-11	FE23-11	
Clear	FE21-12	FE22-12	FE23-12	
Silver	FE21-13	FE22-13	FE23-13	
Brown	FE21-14	FE22-14	FE23-14	
Warm orange	FE21-15	FE22-15	FE23-15	
Banana yellow	FE21-16	FE22-16	FE23-16	
Yellow	FE21-17	FE22-17	FE23-17	
Deep purple	FE21-18	FE22-18	FE23-18	
Light violet	FE21-19	FE22-19	FE23-19	
Neon purple	FE21-20	FE22-20	FE23-20	
Light pink	FE21-21	FE22-21	FE23-21	
Hot pink	FE21-22	FE22-22	FE23-22	
Red	FE21-23	FE22-23	FE23-23	
Dark red	FE21-24	FE22-24	FE23-24	
Apple green	FE21-25	FE22-25	FE23-25	
Turquoise	FE21-26	FE22-26	FE23-26	
Lake blue	FE21-27	FE22-27	FE23-27	
Rust red	FE21-28	FE22-28	FE23-28	
Dark blue	FE21-29	FE22-29	FE23-29	
Prussian blue	FE21-30	FE22-30	FE23-30	
Violet	FE21-31	FE22-31	FE23-31	
Bright green	FE21-32	FE22-32	FE23-32	
Lavender	FE21-33	FE22-33	FE23-33	
Dark black	FE21-34	FE22-34	FE23-34	
Deep pink	FE21-35	FE22-35	FE23-35	
Coral	FE21-36	FE22-36	FE23-36	

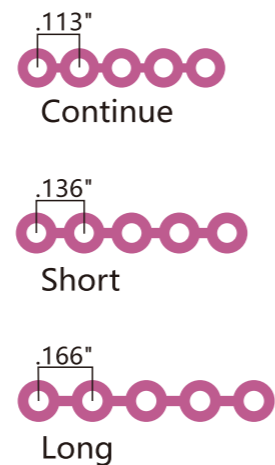

Elastic-Ring >>

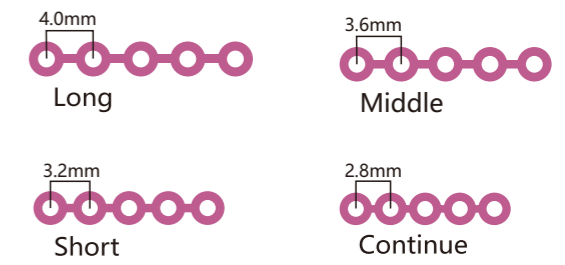
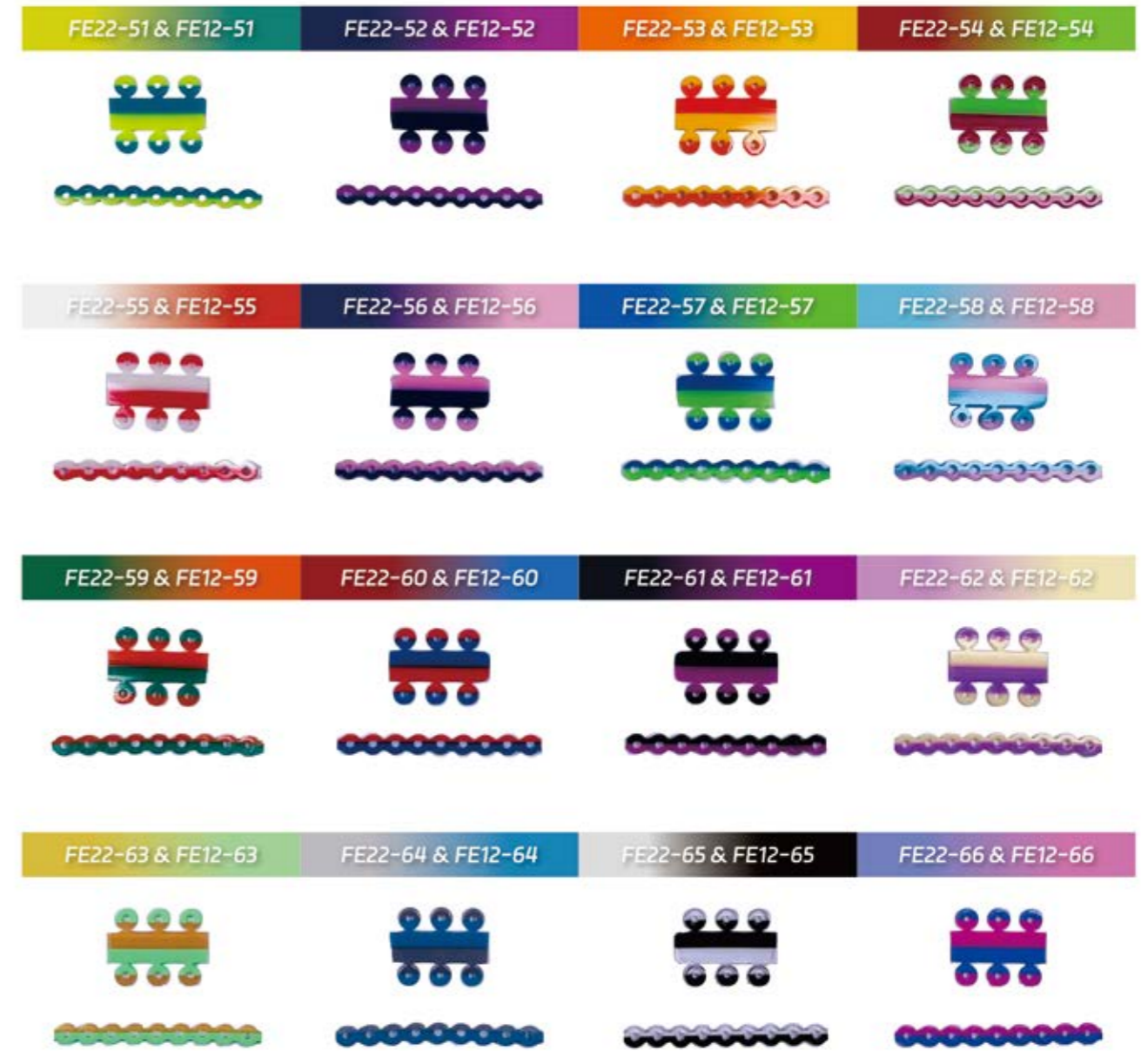

Elastic-Ring >>

• Two Tone Ligature Tie

Color	ITEM NO.	Package	Color	ITEM NO.	Package
	TYPE T			TYPE T	
	FE12-51	20*16 320pcs/bag		FE12-59	20*16 320pcs/bag
	FE12-52			FE12-60	
	FE12-53			FE12-61	
	FE12-54			FE12-62	
	FE12-55			FE12-63	
	FE12-56			FE12-64	
	FE12-57			FE12-65	
	FE12-58			FE12-66	

• Two Tone Power Chain

Color	ITEM NO.	ITEM NO.				Package
		long	middle	short	continue	
	FE21-51	FE24-51	FE22-51	FE23-51	15feet/roll	
	FE21-52	FE24-52	FE22-52	FE23-52		
	FE21-53	FE24-53	FE22-53	FE23-53		
	FE21-54	FE24-54	FE22-54	FE23-54		
	FE21-55	FE24-55	FE22-55	FE23-55		
	FE21-56	FE24-56	FE22-56	FE23-56		
	FE21-57	FE24-57	FE22-57	FE23-57		
	FE21-58	FE24-58	FE22-58	FE23-58		
	FE21-59	FE24-59	FE22-59	FE23-59		
	FE21-60	FE24-60	FE22-60	FE23-60		
	FE21-61	FE24-61	FE22-61	FE23-61		
	FE21-62	FE24-62	FE22-62	FE23-62		
	FE21-63	FE24-63	FE22-63	FE23-63		
	FE21-64	FE24-64	FE22-64	FE23-64		
	FE21-65	FE24-65	FE22-65	FE23-65		
	FE21-66	FE24-66	FE22-66	FE23-66		

• Glow In The Dark Ligature Tie

FE11-00

- 1.Light Source: LED (purple output recommended for optimal absorption)
- 2.Duration: > 3 hours
- 3.Presentation Environment: Complete darkness

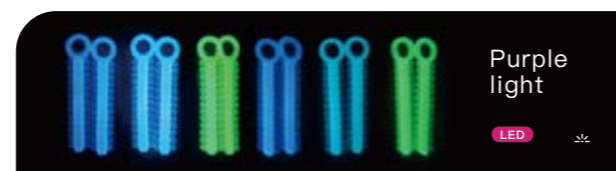
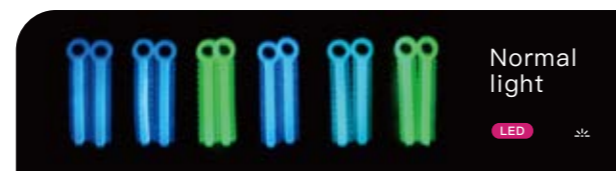

Elastic-Ring >>

• O-Rings

Specification	light	Medium	Heavy	Package
	3.50Z	50Z	6.50Z	50*100pcs/box
Chipmunk 1/8"(3.2mm)	FE41-001	FE41-002	FE41-003	
Rabbit 3/16"(4.8mm)	FE41-011	FE41-012	FE41-013	
Fox 1/4"(6.4mm)	FE41-021	FE41-022	FE41-023	
Penguin 5/16"(8mm)	FE41-031	FE41-032	FE41-033	
Monkey 3/8"(9.5mm)	FE41-041	FE41-042	FE41-043	



Elastic-Ring >>

• O-Rings Multicolored

Specification	2.50Z	3.50Z	4.50Z	6.50Z	Package
1/8"(3.2mm)	FE42-001	FE42-002	FE42-003	FE42-004	5000pcs/box
3/16"(4.8mm)	FE42-011	FE42-012	FE42-013	FE42-014	
1/4"(6.4mm)	FE42-021	FE42-022	FE42-023	FE42-024	
5/16"(8mm)	FE42-031	FE42-032	FE42-033	FE42-034	
3/8"(9.5mm)	FE42-041	FE42-042	FE42-043	FE42-044	



mixed: purple, orange,
black, pink, green

Elastic-Ring >>

• Elastic Directors

Specification	Color	Item No.	Package
	Mix colors	FEL1-01	50*1



• Elastic Thread (Solid)

Specification	Size	Color	Item No.	Package
	0.020"	Clear	FTLX-01	25feet*1
		Silver	FTLX-02	
	0.025"	Clear	FTLX-03	
		Silver	FTLX-04	
	0.030"	Clear	FTLX-05	
		Silver	FTLX-06	

• Tissue Guard (Archwire Sleeve)

Specification	Size	Color	Item No.	Package
	0.037"	Clear	FYGS-01	5m*1
		Silver	FYGS-02	

• Separators

Specification	Item No.	Package
	FE32-01	700*1
	FE32-11	1000*1
	FE32-12	

• Ligature Gun

Specification	Color	Item No.	Package
	Blue	FE00-01	1*1
	Silver	FE00-02	1*1

• Cartoon Ligature Tie

Specification (Mixed Color)	Item No.	Package
 Kitty Cat	FEK12	1000pcs/bag
 Flower	FEF12	1000pcs/bag
 Mickey	FEM12	1000pcs/bag

• Personalized Ligature Tie

Specification	Shape	Color	Item No.	Package
	Star	FE12-S1H	200*1	
		FE12-S1B		
		FE12-S1L		
	Love	FE12-L1H		
		FE12-L1Z		
		FE12-L1F		
	Flower	FE12-F1F		
		FE12-F1Z		
	Smile	FE12-S2H		

• Ligature Tie Placer

Specification	Item No.	Package
Universal	F106-01	1*1



• Rotating Wedge

Specification	Color	Item No.	Package
	Clear	FE51-01	2*1
	Clear	FE51-02	10*1
	Silver	FE51-03	

• Lip Bumper For Braces

Specification	Size	Item No.	Package
	210mm	FTCB-01	2*1

• Mini Orthodontic Accessories Injection Mould

Specification	Instructions	Item No.
   Package: 6*1	Lingual Button Injection Mould 	
	Bite Turbo Injection Mould 	
	Tongue Tamer Injection Mould 	
	Mini Tube Injection Mould 	
	Bracket Injection Mould 	
	lingual wire Bondable Injection mould 	

• Crimpable Hook

Universal Crimpable Split Stops

fixed on the arch wire to keep it from moving. length 2mm

Item No.:F051-01 10pcs/pk



Crimpable Mini Stops

fixed on the arch wire to keep it from moving. length 2mm

0.8mm(large)
Item No.:F051-02 10pcs/pk

0.5mm(small)
Item No.:F051-03 10pcs/pk



Crimpable DoubleTubes

fixed on the arch wire to facilitate other accessories

Item No.:F056-01 10pcs/pk



Crimpable CrossTubes

fixed on the arch wire to facilitate other accessories

Item No.:F056-02 10pcs/pk



Universal Sliding Ball Hook

L: 3.1mm(Common)
1.6/2.1/ 2.7/4/5.5/7mm

Item No.:F052-01 10pcs/pk



Bondable Button Tube

Options:
0.022" Only

Item No.:FZJF-01 10pcs/pk



Crimpable Hook Round

L: 2.1mm(Common)
1.6/1.8/2.7/3.1/4/5.5/7mm

Item No.:F053-02 10pcs/pk



Crimpable Hook Square

L: 2.1mm(Common)
1.6/1.8/2.7/3.1/4/5.5/7mm

Item No.:F053-01 10pcs/pk



Crimpable Hook With 90 Degree Bending Right

Fixed on dental arch wire to prevent arch wire movement

Item No.:F057-02 10pcs/pk



Crimpable Hook With 90 Degree Bending Left

Fixed on dental arch wire to prevent arch wire movement

Item No.:F057-01 10pcs/pk



Sliding Crimpable Hook Right

L: 5.4mm(Common)
2.1mm/3.1mm

Item No.:F054-02 10pcs/pk



Sliding Crimpable Hook Left

L: 5.4mm(Common)
2.1mm/3.1mm

Item No.:F054-01 10pcs/pk



Long Curved Crimpable Hook Right

L: 7mm(Common)
4.5mm/5.3mm

Item No.:F055-02 10pcs/pk



Long Curved Crimpable Hook Left

L: 7mm(Common)
4.5mm/5.3mm

Item No.:F055-01 10pcs/pk



Inside Oral Cavity >>

Inside Oral Cavity >>

Bondable Sliding Crimpable Hook Left

Fixed on dental arch wire to prevent arch wire movement

Item No.:F054-03 10pcs/pk



Bondable Sliding Crimpable Hook Right

Fixed on dental arch wire to prevent arch wire movement

Item No.:F054-04 10pcs/pk



Arch Hook Curve Slide-On

10pcs/pk

16×22" L	FDGF-01
16×22" R	FDGF-02
17×25" L	FDGF-03
17×25" R	FDGF-04
19×25" L	FDGF-05
19×25" R	FDGF-06

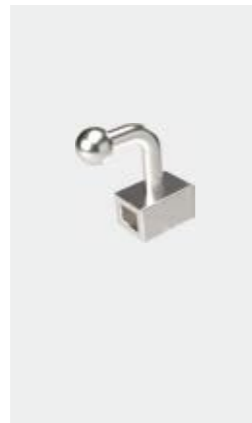

Arch Hook Straight Slide-On

10pcs/pk

16×22"	FDGF-07
17×25"	FDGF-08
19×25"	FDGF-09



2 Hooks with Auxiliary tube Left

Item No.:F058-041 10pcs/pk



2 Hooks with Auxiliary tube Right

Item No.:F058-042 10pcs/pk



Activity Crimpable Hook With Hook

Long: 5.7mm Short: 3.3mm

Item No.:F058-01 left 10pcs/pk+right 10pcs/pk



Eruption Eyelet Single tube

Item No.:FSXQ-01 10pcs/pk

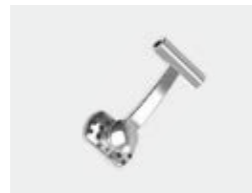

Activity Crimpable Hook Without Hook

Item No.:F058-02 10pcs/pk



Eruption Eyelet Double tube

Item No.:FSXQ-02 10pcs/pk



Bondable Double Hooks

Lingual Buttons 9.83mm

Item No.:F058-03 10pcs/pk



Y Hook (Left)

(Long) 8mm (Middle) 7mm (Short) 5mm

Item No.:F058-05L 10pcs/pk



Y Hook (Right)

(Long) 8mm (Middle) 7mm (Short) 5mm

Item No.:F058-05R 10pcs/pk



10pcs/bag



Gold chain



50pcs/box

• Lingual Buttons

Bondable Button

Round
Item No.:F012-01 10pcs/pk



Bondable Hole

mushroom shaped headlock button and base has arched contour

Item No.:F012-03 10pcs/pk

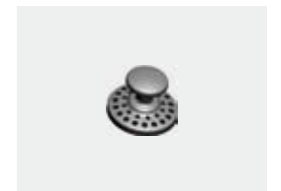

Rectangular
Item No.:F012-02 10pcs/pk

Composite Lingual Button

Round
Item No.:F012-04 10pcs/pk



Ceramic Clear Lingual Button

Round
Item No.:F012-06 10pcs/pk



Rectangular
Item No.:F012-05 10pcs/pk

Rectangular
Item No.:F012-07 10pcs/pk

Ceramic Clear Lingual Button with hook

Item No.:F012-08 10pcs/pk



Bondable Lingual Button with hook

Round
Item No.:F012-09 10pcs/pk

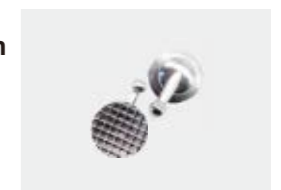

Inside Oral Cavity >>

Bondable Lingual Cleat Small

Can be directly bonded on tooth surface, a traction with its resistance
Item No.:F012-11 10pcs/pk

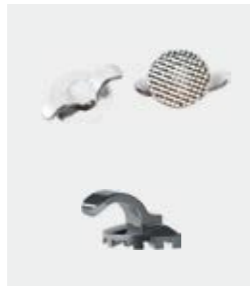

Bondable Lingual Button with Single Cleat

Item No.:F026-01 10pcs/pk



Bondable Lingual Button with Small cleat with horizontal hole

Item No.:F026-02 10pcs/pk



Bondable Lingual Button with Small Cleat with vertical hole

Item No.:F026-03 10pcs/pk



Traction Hook

Round
Item No.:F023-01 10pcs/pk



Rectangular
Item No.:F023-02 10pcs/pk

Bite Opener

Item No.:F025-01 10pcs/pk



Tongue Tamers

Item No.:F025-02 10pcs/pk



Golden Button Chain +Direct Bond Eyelet

Round
Item No.:F023-12GR 2pcs/pk



Rectangular
Item No.:F023-12GS 2pcs/pk

Bondable Lingual Button with Auxiliary Hole

Item No.:F026-13 10pcs/pk



Direct Bond Eyelet

Round
Item No.:F024-01 10pcs/pk



Rectangular
Item No.:F024-02 10pcs/pk

Weldable Button

Round
Item No.:F011-01 10pcs/pk



Rectangular
Item No.:F011-02 10pcs/pk

Weldable Lingual Cleat

Small
Item No.:F022-11 10pcs/pk



Big
Item No.:F022-10 10pcs/pk

Seating Lug

Item No.:F021-11 10pcs/pk



Silver Button Chain +Direct Bond Eyelet

Round
Item No.:F023-12SR 2pcs/pk

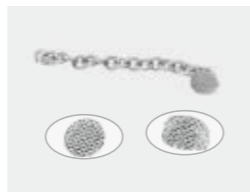

Rectangular
Item No.:F023-12SS 2pcs/pk

Inside Oral Cavity >>

Lingual Sheath With Vertical Tube No Hook



10pcs/pk

Specification	Item No.
vertical tube no Hook	FDZE-01

Lingual Sheath



10pcs/pk

Remark

· Pre-weld on the band to go with the palatal bars

Specification	Item No.
no hook no indent	F041-01
no hook w/indent	F041-02
mesial w/hook no indent	F042-01
distal w/hook no indent	F042-02
distal w/hook w/indent	F043-01
mesial w/hook w/indent	F043-02

Molar Pusher

Remark

· Mainly used to push molars to the middle.



2pcs/pk

Specification	Item No.
Molar Pusher 1G	FMP01-01
Molar Pusher 2G Left	FMYH-01
Molar Pusher 2G Right	FMYH-02

Lingual Retainer Bonding Splints



2pcs/pk

Specification	Size	Item No.
Universal	L60mm X W2mm	F033-01

Remark

· Mainly applied to maintain the effect after the orthodontic treatment.



2pcs/pk

Specification	Item No.
Maxillary U38	F031-38
Maxillary U40	F031-40
Maxillary U42	F031-42
Maxillary U45	F031-45
Maxillary U47	F031-47
Mandibular L29	F032-29
Mandibular L31	F032-31
Mandibular L33	F032-33
Mandibular L35	F032-35
Mandibular L37	F032-37

Palatal Arch Bar

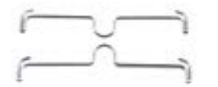

Remark

· It is generally used in combination (palate rod, one on each side of the palate tube), mainly used to control the rotation of the molar and slightly expand the upper dental arch.

2pcs/pk

Mesial Loop

F094-37L F094-39L F094-41L F094-43L F094-45L
F094-47L F094-49L F094-51L F094-53L F094-55L

Distal Loop

F094-37R F094-39R F094-41R F094-43R F094-45R
F094-47R F094-49R F094-51R F094-53R F094-55R



Inside Oral Cavity >>

Expansion Screw

Remark

The products are mainly used in dentistry dentition orthodontic arch extensions for arch stenosis and posterior crossbite patients.

1pc/pk

Specification	Item No.
Mini	FPE1-1000
Standard	FPE1-1001
Expansion Screw	8mm FPE1-1008
	9mm FPE1-1009
	11mm FPE1-1011
	13mm FPE1-1013
Low Jaw	8mm FPE1-1108
	9mm FPE1-1109
	11mm FPE1-1111
	13mm FPE1-1113
Swivel keys Universal	FPE0-1000

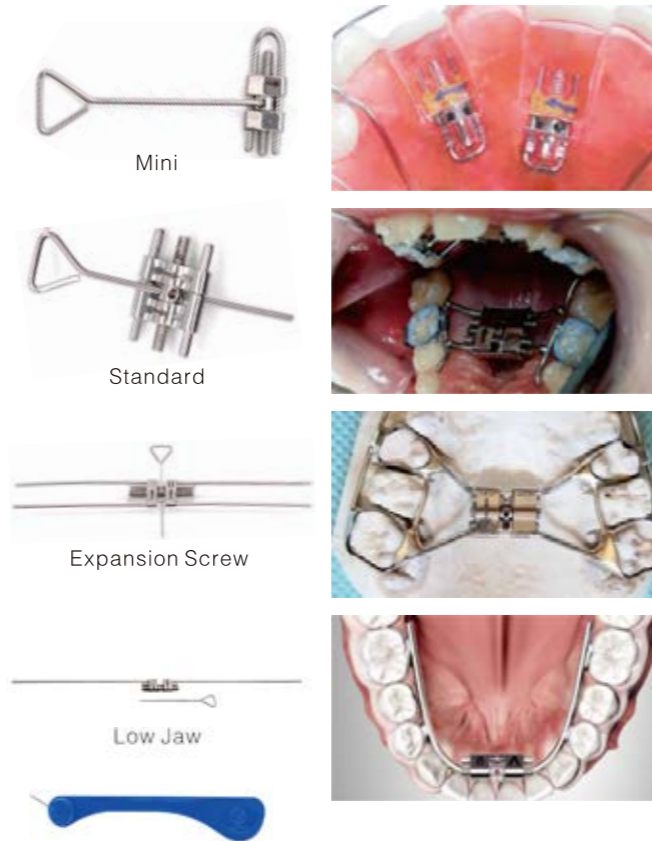

ForcePro Class II Correctors

Remark

- +2 Fatigue Resistant Device
- +2 Push Rod
- +3 L-Pins
- +2 Crimps

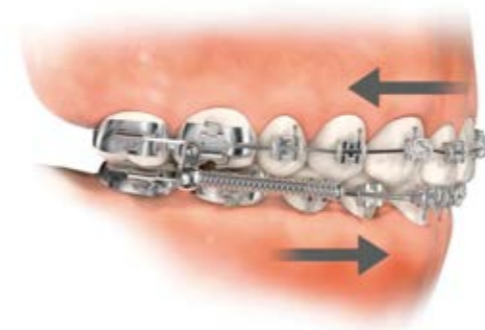

Key Features

- One-step installation into the headgear tube
- Telescoping spring allows natural jaw movement
- Slim stainless steel design minimizes cheek contact
- Fatigue-resistant spring ensures long service life
- Open coil design promotes oral hygiene
- No lab work - chairside fitting in one appointment
- Left and right sides work independently

Installation using



Specification	Item No.
22mm	FCYH-01
25mm	FCYH-02
29mm	FCYH-03
32mm	FCYH-04
35mm	FCYH-05
38mm	FCYH-06

Inside Oral Cavity >>

Metal Class II Distalizer

Remark

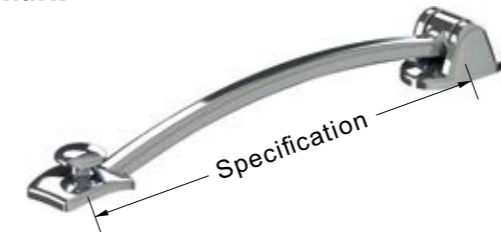

2*1

Specification	Item No.
27mm	FYDQ-01
25mm	FYDQ-02
23mm	FYDQ-03
20mm	FYDQ-04
18mm	FYDQ-05
16mm	FYDQ-06



Clear Class II Distalizer

Remark

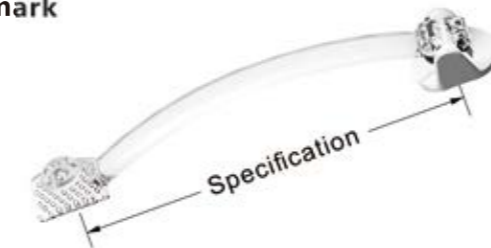

2*1

Specification	Item No.
16mm	FTYD-06
18mm	FTYD-05
20mm	FTYD-04
23mm	FTYD-03
25mm	FTYD-02
27mm	FTYD-01



Micro Implant

Remark

- There are two optional materials : titanium, stainless steel.
- other customized micro implant are available.

1pc/pk

Specification	Item No.
dia. 1.4*6mm	FMI-1406
dia. 1.4*8mm	FMI-1408
dia. 1.4*10mm	FMI-1410
dia. 1.6*6mm	FMI-1606
dia. 1.6*8mm	FMI-1608
Titanium dia. 1.6*10mm	FMI-1610
dia. 1.6*12mm	FMI-1612
dia. 2.0*6mm	FMI-2006
dia. 2.0*8mm	FMI-2008
dia. 2.0*10mm	FMI-2010
dia. 2.0*12mm	FMI-2012



Micro Implant Tool

Remark

- Arc-head & smaller hexagonal Head:
- Avoid hurting the soft tissue, shorten the length and ground head without rough angel to reduce the feeling of foreign body;
- beautiful handle,compliant with yahong all mini screw size ,
- Improving the efficiency of insertion to avoid any broken tip.

Item No.	Package
FMI01-01	1pc/box



Micro Implant Positioner

Remark

- When planting anchor nails, we can take a picture to choose a good location and put the locator on the arch wire to position, so that you can avoid hitting the wrong position, which is very convenient.

10pcs/pk

Specification	Item No.
Micro Implant Positioner	F059-01

• Invisible Attachments

Root Control Attachment

Remark



Short Long 10*1

Specification	Item No.
Short	FYJZ-01
Long	FYJZ-02

Chewies

Remark



2*1

Specification	Item No.
Mango	FE32-02
Primary	FE32-03
Orange	FE32-04
Strawberry	FE32-05
Mint	FE32-06
Grape	FE32-07
Lemon	FE32-08
Blueberry	FE32-09
Banana	FE32-10
Mojito	FE32-11
Kiwi	FE32-12
Taro	FE32-13
Peach	FE32-14

Invisible Tooth Removal

Remark



1*1

Specification	Item No.
Red	FYXY-01
Yellow	FYXY-02
Green	FYXY-03
White	FYXY-04
Blue	FYXY-05

Denture Box

Remark



1*1

Specification	Item No.
White	F121-01W
Yellow	F121-01Y
Green	F121-01G
Blue	F121-01B
Pink	F121-01P

Cheek Retractor

Remark

- Great for initial bonding giving you a full view of anterior and posterior teeth
- Breakage resistant
- Autoclavable up to 130°C



10pcs/pk

Specification	Item No.
Clear Large	F071-01
Clear Medium	F071-02
Clear Small	F071-03

Expando Cheek Retractor

Remark

- Great for initial bonding to provide you with maximum view for the whole teeth
- Tongue depressor ensure field dryness
- Breakage resistant crystal clear plastic tray.
- Autoclavable up to 130°C
- Ultra-smooth surface for maximum patient's comfort



2pcs/pk

Specification	Item No.
Clear Large	F073-01
Clear Medium	F073-02
Clear Small	F073-03

Super Cheek Retractor

Remark

- This retractor has an extra wings to push the cheek further away from buccal dentition
- Autoclavable up to 270° F (132°C)
- Ultra-smooth surface for maximum patient's comfort



1pc/pk

Specification	Item No.
White Large	F075-01
White Medium	F075-02
White Small	F075-03

Lip Ring Retractor

Remark

- Great protection for lips during interproximal stripping
- Cold sterilizable
- High medical grade plastic
- Universal size for children and adults



10pcs/pk

Specification	Item No.
Standard Blue	F074-01
Standard White	F074-02

Dry Field System

Remark

- The new multifunctional opening device can be disassembled and assembled according to different needs
- Block tongue, suck saliva, size can be adjusted



1pc/pk

Specification	Item No.
Green	F078-01
Blue	F078-02

Multi-Function Tongue Retractor

Remark

- Used to expand the lips when bonding brackets, using imported food grade raw materials that have no toxic side effects on the human body. Disinfection can be achieved by using either disinfectant or 134 °C steam sterilization



1pcs/pk

Specification	Item No.
Clear	F080-01

Both Sides Cheek Retractor

Remark

- Designed with one end to hold the cheek away and the other end to hold the entire lip away for an improved Intraoral photography
- Autoclavable up to 130°C
- Ultra-smooth surface for maximum patient's comfort



2pcs/pk

Specification	Item No.
Clear	F076-02

Lip And Cheek Retractor

Remark

- Imported food-grade raw materials are used, without any toxic and side effects on the human body, and disinfectant can be used or 120°C steam sterilization



1pc/pk

Specification	Item No.
General	F079-01

Lip Retractor

Remark

- Designed with one end to hold the cheek away and the other end to hold the entire lip away for an improved intraoral photography
- Autoclavable up to 130°C
- Ultra-smooth surface for maximum patient's comfort



2pcs/pk

Specification	Item No.
Adult	F072-01
Child	F072-02

Buccal Cheek Retractor

Remark

- It is mainly used to stretch the lips and cheeks and open the oral cavity during dental treatment to expand the treatment field and facilitate the operation of the doctor.



2pcs/pk

Specification	Item No.
Clear	F077-03

Lip Fork

Remark

- Allowed (120~140°C) high temperature and high pressure sterilization.



2pcs/pk

Specification	Item No.
Clear	F077-01

Lip Hook

Remark

- For photo inspection, it can be sterilized by high temperature and high pressure at 135°C.



2pcs/pk

Specification	Item No.
Clear	F077-02

Double Side Photo Mirror Metal

Remark



A-2

B-2

1pc/pk

Specification	Item No.
Fold (A-2)	F083-01
Fold (B-2)	F083-02

Photo Mirror Metal

Remark

- Manufactured with high grade stainless steel and coated with nickel chromium for maximum reflective qualities. The mirrors have polished, rounded edges for patient comfort. Stainless Steel nickel chromium coating Reflectivity close to 100% True color representation 134°C Autoclavable.

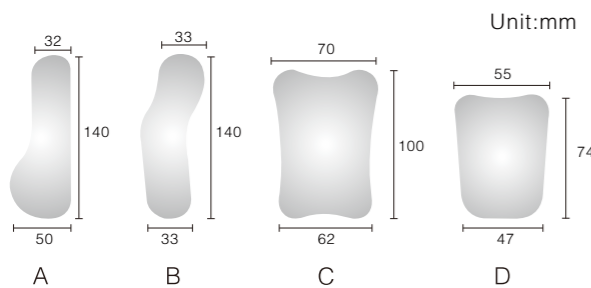

Unit:mm

1pc/pk 4pcs/set

Specification	Item No.
lingual (A)	F081-01
buccal (B)	F081-02
adult occlusal (C)	F081-03
child occlusal (D)	F081-04

Mirror Holder

2pcs/box

image	Specification	Item No.
	For Glass use Applicable for a thickness of 2.5mm	FFGJ-01
	For Metal use Applicable for a thickness of 1.5mm	FFGJ-02

Photo Mirror Glass

Remark

- The photography mirror is 134°C Celsius autoclavable. (NOTE: Do not use liquid disinfecting Detergent for the mirror, since Liquid disinfectant can damage the coating on the mirror surface) Titanium plating, reflectivity close to 95%, easily reflect the real oral situation during oral photography. The occlusal mirror is used for intraoral photography, high durability for repetitive work, ideal dental tools.

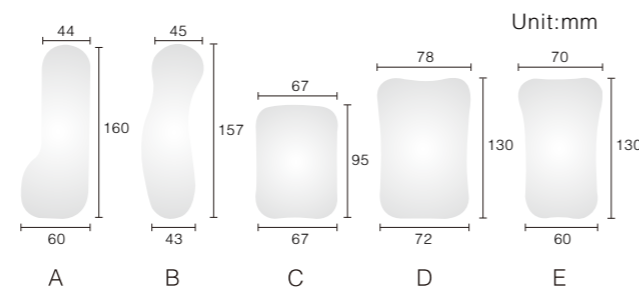

Unit:mm

1pcs/pk 5pcs/set

Specification	Item No.
lingual (A)	F082-01
buccal (B)	F082-02
occlusal-Adult (C)	F082-03
occlusal-XL Adult (D)	F082-04
occlusal M (E)	F082-05

Forward Pull Headgear (Single Bar)

Remark

- Mesial movement of laterals in upper and lower jaw. Movement of groups of teeth in the arch. Adjustable protraction of anterior segments.



Specification	Color	Item No.
Single Bar (1pc/pk)	Red	F091-01R
	Yellow	F091-01Y
	Blue	F091-01B
	Green	F091-01G
	White	F091-01W
Cartoon styles (1pc/pk)	Dinosaur	F091-01D
	Star	F091-01S

Double Bars

1pc/pk

Specification	Item No.
Double Bars	F091-02



Universal

1pc/pk

Specification	Item No.
Red	F091-03
Blue	F091-04



Face Bows

Remark

- Universal inner bow diameter is 0.045
- Two friction stops at each end of the inner bow
- Outer bow non-angulated

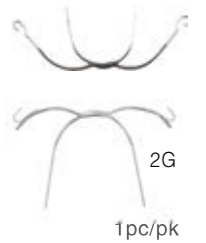

Specification	Item No.
Universal	F062-01
Universal 2G	F062-02

Remark

- Inner bow with cuspid hooks
- Outer bow non-angulated
- Inner bow diameter is with variations to different needs

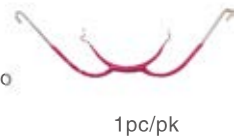

Specification	Item No.
W/cuspid hook 83mm	F061-01
W/cuspid hook 90mm	F061-02
W/cuspid hook 97mm	F061-03
W/cuspid hook 104mm	F061-04
W/cuspid hook 111mm	F061-05

Chin Cup

Remark

- Two hooks can bear the tension of 10N to provide anchorage, used together with headgear.



1pc/pk

Specification	Item No.
Leather	F092-01
Cotton	F092-02

J Hook

Remark

- With bicuspid hook



2pcs/pk

Specification	Item No.
J Hook	F093-01

Safety Module

Remark

· It'll slide open when the outer force surpasses 2kg.



2pcs/pk

Specification	Item No.
Safety Module	F101-01

High Pull Headgear

Remark

· Consists of headgear and safety modules, used with chin cup, face bow, J hook and other accessories.



1pc/pk

Specification	Item No.
Big	F103-01
Medium	F103-02
Small	F103-03

Neck Safety Strap

Remark

· Above 25N when subjected to external forces, safety belt neck collar will automatically disengage.



1pc/pk

Specification	Item No.
Neck Safety Strap	F102-01

Combination Headgear

Remark

· Consists of Headgear and safety modules, cooperated with face bow, J hooks and other accessories.



1pc/pk

Specification	Item No.
Big	F104-01
Medium	F104-02
Small	F104-03

PLIERS & TOOLS



- Orthodontic pliers 151
- Orthodontic tools 154

Orthodontic pliers >>



Light wire plier With cutter
Item No.: FC01-01 Package: 1*1
Suitable for all different sizes of delicate loops and springs. Cutting edge, in the middle part of the bird beak, is stiff and sharp. It can be used to cut surplus wire, for round wires not up to 0.6mm and rectangular wires not up to 0.56*0.71mm.



Light wire plier Without cutter
Item No.: FC01-02 Package: 1*1
Suitable for all different sizes of delicate loops and springs. For round wires not up to 0.6mm and rectangular wires not up to 0.56*0.71mm.



Light wire plier Multi-Bend Forming
Item No.: FC01-03 Package: 1*1
Suitable for all different sizes of delicate loops and springs. For round wires not up to 0.6mm and rectangular wires not up to 0.56*0.71mm.



Distal end cutter Standard
Item No.: FC02-01 Package: 1*1
Suitable for cutting the end of longer wires. the beak is in special form so that wire ends will not shoot out to the mouth but stay at the beak. For wire not up to 0.56*0.71mm.



Distal end cutter King-size
Item No.: FC02-02 Package: 1*1
Suitable for cutting the end of longer wires. the beak is in special form so that wire ends will not shoot out to the mouth but stay at the beak. For wire not up to 0.56*0.71mm.



Distal end cutter Flush
Item No.: FC02-03 Package: 1*1
It's special "u" tips can be used to truncate the long end of wires parallel to tubes. its cutting capacity: 0.016"-0.018"*0.022".



Torque bending plier Item No.: FC05-02 Package: 1*1
For applying torque to edgewise. Often used in pairs. For hard wires not up to 0.56*0.71mm.

Orthodontic pliers >>>



Loop forming plier Tweed plier
Item No.: FC07-01 Package: 1*1
For bending loops on the wires. Especially stop loops and omega loops.



Kim plier Item No.: FC06-01 Package: 1*1
For bending multi-loop edgewise arch wires. With cutter in the middle part. For rectangular wires not up to 0.022". three step loop formers are 1.5mm, 2mm, 2.6mm.



Brackets removing plier For anterior teeth
Item No.: FC12-01 Package: 1*1
For removing brackets by cutting the adhesive part.



Brackets removing plier For posterior teeth
Item No.: FC12-02 Package: 1*1
For removing brackets by cutting the adhesive part.



Band removing plier Item No.: FC13-01 Package: 1*1
Under the fulcrum of stainless steel pad occlusal point, it removes the posterior bands with long slending chisel tip. Also for removing brackets.



Crimpable hook placement Item No.: FC16-01 Package: 1*1
For locking sliding tubes onto the wire, making locking easier.

Orthodontic pliers >>



Separator placing plier Heavy wire cutter
Item No.: FC17-01 Package: 1*1
Bending in the front to make it easier to put separating modules under the molar contact point.



Buccal tube convertible cap removing plier
Item No.: FC18-01 Package: 1*1
Used for convertible buccal tubes.



Distal end bending plier King-Size
Item No.: FC26-01 Package: 1*1
It is mainly used to bend the end of hard wires. Especially the niti wires. There is no need to heat the niti wires when they are bended by these pliers, its maximum bending capacity is 0.021" in diameter.



Distal end bending plier Twin Heads
Item No.: FC26-02 Package: 1*1
It is mainly used to bend the end of hard wires. Especially the niti wires. There is no need to heat the niti wires when they are bended by these pliers, its maximum bending capacity is 0.021" in diameter.



Weingart plier Item No.: FC10-01 Package: 1*1
Long slender curved lip-safe lips with beak. For positioning the arch to the buccal tubes, uncovering convertible buccal and bending the arch wire ends at the back of tubes, etc.

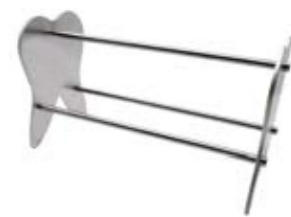

Stand for pliers Item No.: FC00-01 Package: 1*1
Made of stainless steel. Suitable for high temperature sterilization.

Orthodontic tools >>



Brackets tweezer Item No.: FD04-01 Package: 1*1
Used for both anterior and posterior teeth with adhesive removing head. It is suitable to remove extra adhesives.



Multi-functional Brackets tweezer Item No.: FD04-02 Package: 1*1



Multi-functional Brackets tweezer Item No.: FD04-03 Package: 1*1



Buccal tube tweezer Item No.: FD05-01 Package: 1*1
It is used to hold the buccal tubes reversely when the buccal tubes are to be bonded. Its slim and curved tips make it more convenient in use.



Tension and stress gauge Item No.: FD05-02 Package: 1*1
For measuring gram and ounce tension force.



Star-like brackets positioning gauge Item No.: FD03-01 Package: 1*1
For anterior teeth and posterior teeth.

